





# DESIGN AND PERFORMANCE

*100% HIGH QUALITY*

2021

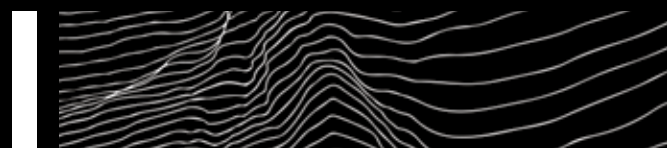

## GONFIATORI

INFLATORS

01

GONFIATORI ELETTRICI / *ELECTRIC PUMPS*  
 GONFIATORI MANUALI / *HAND PUMPS*  
 GONFIATORI A PEDALE / *FOOT PUMPS*

6 - 49

## REMI E PAGAIE

OARS AND PADDLES

02

REMI / *OARS*  
 PAGAIE / *PADDLES*

50 - 69

## ACCESSORI

ACCESSORIES

03

MANOMETRI / *PRESSURE GAUGES*  
 VALVOLE / *VALVES*  
 RACCORDI / *FITTINGS*  
 COMPONENTI / *PARTS*

70 - 105

## RICAMBI

SPARE PARTS

04

RACCORDI E TUBI / *FITTING AND HOSE*  
 VALVOLE E COMPONENTI / *VALVES AND PARTS*  
 ALIMENTAZIONE / *ELECTRIC SUPPLY*  
 BORSE / *BAGS*  
 RICAMBI ACCESSORI SUP / *SPARE*  
*PARTS FOR SUP ACCESSORIES*

106 - 121

# GONFIATORI

INFLATORS

# 01





PERFORMANCE DI GONFIATORI SU SERBATOIO DA 500 LITRI  
INFLATORS PERFORMANCE ON 500 LITRES METALLIC RESERVOIR

MAX  
PRESSURE  
(mbar)

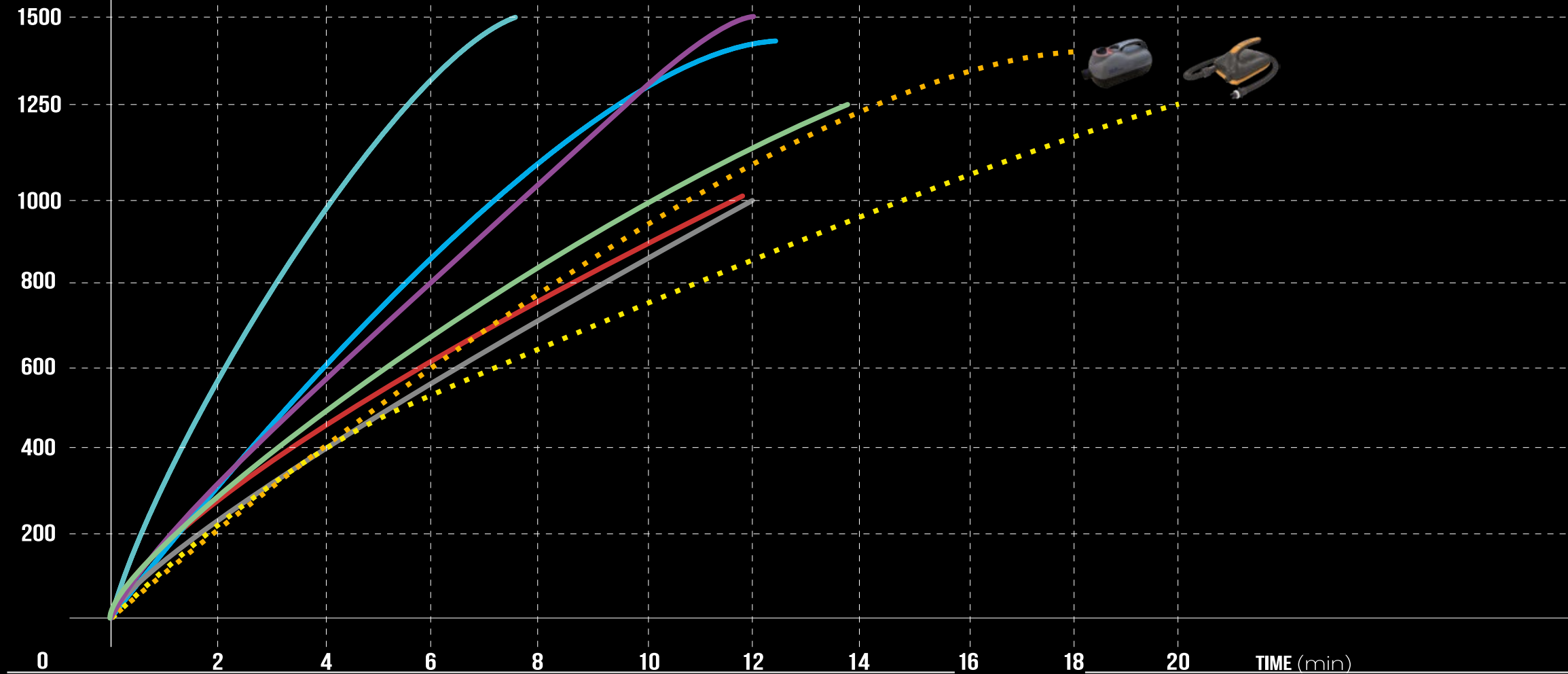

- GE 25
- GE 20-2
- GE 21-1A
- GE BTP
- GE BP
- GE BP-1
- HO LEE
- STERMAY

# POMPE ELETTRICHE 12V/230/120

ELECTRIC PUMPS 12V/230/120

## GE 25

- Gonfiatore elettrico per applicazioni ad alta pressione, ampio flusso d'aria
- Commutazione automatica dalla fase turbina alla fase doppio compressore
- Facile impostazione della pressione desiderata tramite il manometro, arresto automatico
- Indicatori LED per lo stato di autonomia della batteria
- Raccordi di gonfiaggio per tutte le più comuni valvole
- Borsetta a tracolla inclusa
- Disponibile in 2 versioni: doppia batteria integrata al piombo o collegamento a rete 230/120 V

- Double Stage electric inflator for high pressure applications, HVHP
- Automatic switch from turbine to double compressor stage
- Easy setting of the desired pressure and pressure control through manometer, automatic stop
- LED indicators for battery status
- Inflation fittings available for the most common valves
- Carry bag included
- Available in 2 versions: Double lead integrated battery or wall plug 230/120V



### MANUALE/INSTRUCTION MANUAL

Item	GE 25 SL	GE 25 AC 230V	GE 25 AC 120V
Part number	K6130900	K6130990	K6130980
Air flow	450 l/min (turbine: up to 80 mbar – 1.15 psi) / 250 l/min (compressor: up to 1,5 bar – 22.0 psi)		
Max. Pressure	1,5 bar (22.0 psi)	1,5 bar (22.0 psi)	1,5 bar (22.0 psi)
Inflate - deflate	INFLATE and DEFLATE	INFLATE and DEFLATE	INFLATE and DEFLATE
Voltage supply	12V	230 V AC, 60 Hz	120V AC, 60Hz
Dimensions	Pump: 37 x 17 x 19 cm / in bag: 41 x 21 x 27 cm		
Weight	10 kg	6 kg	6 kg
Construction	ABS + PA	ABS + PA	ABS + PA
Suitable for	ALL KIND OF INFLATABLES	ALL KIND OF INFLATABLES	ALL KIND OF INFLATABLES

Tutti i manuali di istruzione dei gonfiatori elettrici sono scaricabili dal sito [www.scoprega.it](http://www.scoprega.it)



All instruction manuals can be downloaded on [www.scoprega.it](http://www.scoprega.it)

# POMPE ELETTRICHE 12V

12V ELECTRIC PUMPS

## GE 20-2

- Gonfiatore elettrico portatile, alta efficienza e rumorosità ridotta
- Gruppo pompante a doppio pistone, nessun relay o microswitch
- Facile impostazione della pressione desiderata tramite il manometro, arresto automatico
- Indicatori LED per lo stato di autonomia della batteria
- Batteria 12V DC integrata, ricaricabile tramite presa accendisigari o trasformatore 110-240 AC/DC
- Equipaggiata con morsetti per alimentazione diretta da batterie 12V esterne
- Sistema di filtraggio protettivo
- Raccordi di gonfiaggio per tutte le più comuni valvole
- Borsetta a tracolla inclusa

- *Portable high efficiency, low noise electric inflator.*
- *Twin cylinder, no relays and microswitches*
- *Wide pressure range selectable by easy of use dial indicator with automatic shut-off*
- *LED indicators for diagnostics*
- *Integrated 12V DC battery, rechargeable through cigarette plug or standard 110-240 AC/DC adaptor*
- *Equipped with alligator clips for direct connection to external 12V batteries*
- *Protective filtration system*
- *Inflation fittings available for all most common valves*
- *Carry-bag included*

### MANUALE/INSTRUCTION MANUAL

<b>Item</b>	GE 20-2
<b>Part number</b>	K6130702
<b>Air flow</b>	125 l/min
<b>Max. Pressure</b>	1,5 bar (22.0 psi)
<b>Inflate - deflate</b>	INFLATE
<b>Voltage supply</b>	12V DC from cigarette plug or from external battery
<b>Dimensions</b>	in bag: 20 x 32 x 22 cm
<b>Weight</b>	6.65 kg
<b>Construction</b>	ABS + PA
<b>Suitable for</b>	BOATS, SUP, KITES, KAYAKS, ALL KIND OF INFLATABLES





# POMPE ELETTRICHE 12V

12V ELECTRIC PUMPS

## GE 21-1A

Nuovo gonfiatore elettrico robusto e veloce per applicazioni ad alta pressione.

- Facile impostazione della pressione desiderata con arresto automatico
- Connessione rapida alla presa accendisigari, sia per il funzionamento che per la ricarica
- Batteria 12V DC integrata, ricaricabile tramite presa accendisigari o trasformatori 110-240 AC/DC
- Borsetta a tracolla inclusa

*New robust and fast inflator for high pressure applications.*

- *Easy setting of desired pressure with automatic stop*
- *Standard connection to cigarette plug for operation and recharge*
- *Integrated 12V DC battery, rechargeable through cigarette plug or standard 110-240 AC/DC adaptor*
- *Carry bag included*

### MANUALE/ INSTRUCTION MANUAL

<b>Item</b>	GE 21-1A
<b>Part number</b>	K6130801
<b>Air flow</b>	125 l/min
<b>Max. Pressure</b>	1,5 bar (22.0 psi)
<b>Inflate - deflate</b>	INFLATE
<b>Voltage supply</b>	12V DC from cigarette plug
<b>Dimensions</b>	in bag: 22 x 32 x 22 cm
<b>Weight</b>	6.40 kg
<b>Construction</b>	ABS + PA
<b>Suitable for</b>	BOATS, SUP, KITES, KAYAKS, ALL KIND OF INFLATABLES





# POMPE ELETTRICHE 12V

12V ELECTRIC PUMPS

## GE BP-1

- Arresto automatico alla pressione selezionata
- Facile impostazione della pressione desiderata tramite il manometro, arresto automatico
- Completo di sacca con tracolla
- Con tubo da 1,70 m e cavo di alimentazione da 3 m
- Fornito con spinotto per presa accendisigari e con morsetti per connessione diretta da batterie 12V esterne
- Filtri protettivi integrati
- Ideale per TAVOLE SUP
- KIT di tubo e raccordi per gommoni, kite e materassini acquistabile come optional

- Automatic stop when selected pressure is reached
- Equipped with shoulder bag
- With 1,70 m tube and 3 m power cord
- Supplied with cigarette lighter plug and with alligator clips for direct connection to external 12V batteries
- Protective filtration system
- Perfect for SUP BOARDS
- KIT of hose and fittings for inflatable boats, kites and mattresses available on demand

KIT acquistabile come optional  
KIT available on demand

KIT AGGIUNTIVO PER GOMMONI, KITE E MATERASSINI  
ADDITIONAL KIT FOR INFLATABLE BOATS, KITE AND MATTRESSES R333370

MANUALE/ INSTRUCTION MANUAL 

Item	Part number	Dimensions	Voltage supply	Current Consumption	Air Flow	Max Pressure
GE BP-1	K6131320	20,5 x 10,5 x 13 cm	12V DC	13 A max	160 l/min	1,2 bar (18 psi)

Tutti i manuali di istruzione dei gonfiatori elettrici sono scaricabili dal sito [www.scoprega.it](http://www.scoprega.it)



All instruction manuals can be downloaded on [www.scoprega.it](http://www.scoprega.it)

# POMPE ELETTRICHE 12V

12V ELECTRIC PUMPS

## GE BTP

- Selezione della pressione semplificata tramite speciale manometro
- Arresto automatico alla pressione selezionata
- Dotato di filtro dell'aria in aspirazione, di facile accesso per la pulizia e/o sostituzione
- Completo di raccordi per gommoni, kites e SUP
- Completo di sacca con tracolla
- Con tubo da 1,70 m e cavo di alimentazione da 3 m
- Può gonfiare e sgonfiare
- Fornito con spinotto per presa accendisigari e con morsetti per connessione diretta da batterie 12V esterne
- Ideale per GOMMONI, KITE e TAVOLE SUP
- Indicatori LED per lo stato di automonia della batteria

- Pressure selection facilitated with this special manometer
- Automatic stop when selected pressure is reached
- Fitted with aspiration air filter, easily accessible for cleaning and replacement
- Equipped with connectors for dinghies, kites and SUP boards
- Equipped with shoulder bag
- With 1.70 m tube and 3 m power cord
- Can inflate and deflate
- Supplied with cigarette lighter plug and with alligator clips for direct connection to external 12V batteries
- Protective filtration system
- Perfect for BOATS, KITES and SUP BOARDS
- LED indicators for diagnostics

Kit batteria acquistabile come optional  
Optional battery available on demand

MANUALE/ INSTRUCTION MANUAL 

Item	Part number	Dimensions	Voltage supply	Current Consumption	Air Flow	Max Pressure
GE BTP	K6131210	29,5 X 10,5 X 16 cm	12V DC	13 A max	120 - 420 l/min	1 bar (14.5 psi)

Tutti i manuali di istruzione dei gonfiatori elettrici sono scaricabili dal sito [www.scoprega.it](http://www.scoprega.it)

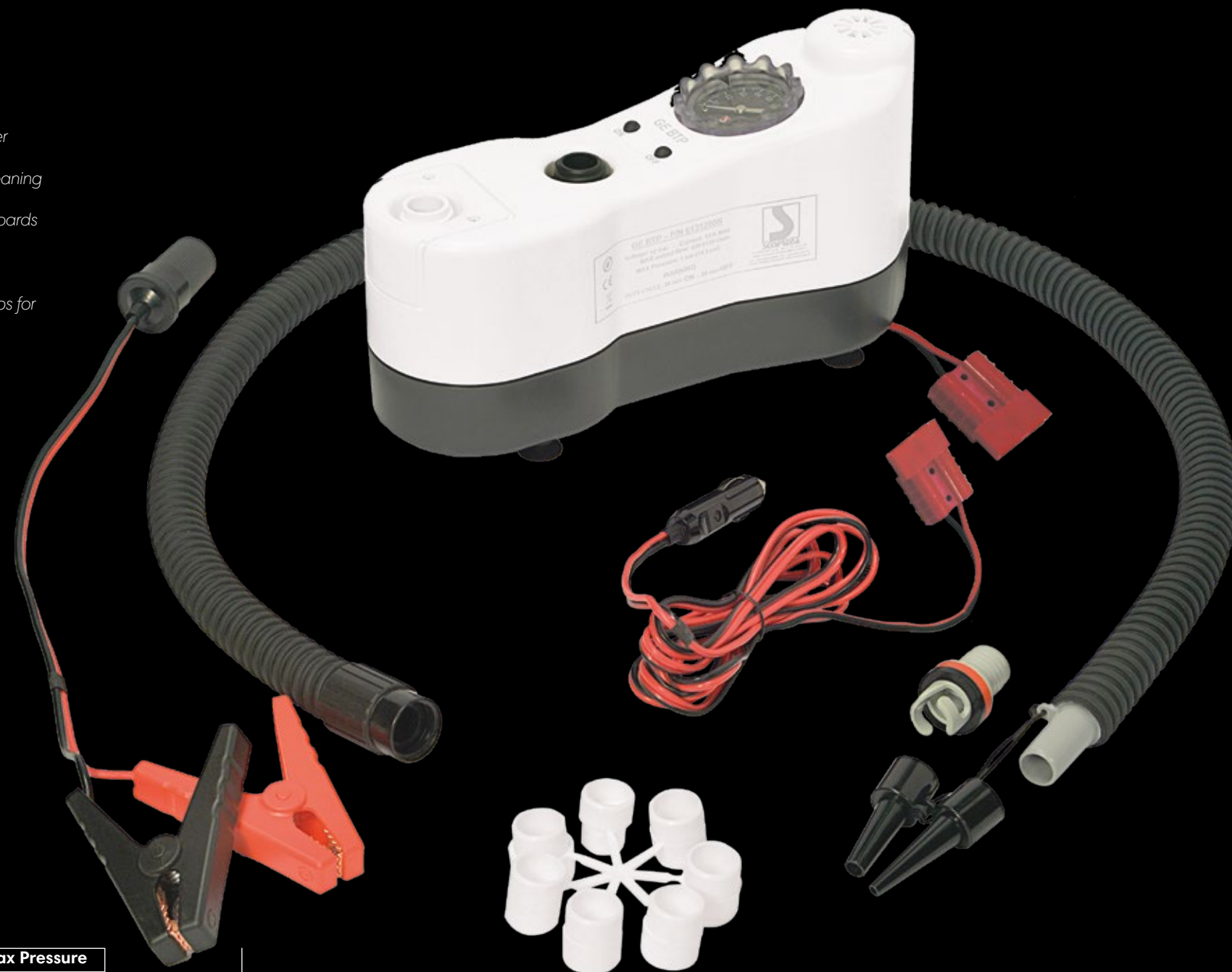

All instruction manuals can be downloaded on [www.scoprega.it](http://www.scoprega.it)

# KIT BATTERIA PER GE BP - GE BTP

BATTERY KITS FOR GE BP - GE BTP

## BATTERIA AL PIOMBO

- Batteria al piombo ricaricabile
- Capacità 9'000 mAh
- Voltaggio 12V
- Massima corrente di scarica 25 A

- Applicabili a tutte le versioni GE BP e GE BTP
- Connessione facilitata ai gonfiatori
- Inseribile nella sacca fornita con GE BP e GE BTP
- Carica batteria (120V / 230V) compreso

- Sealed Lead Acid Pb Rechargeable Battery
- Nominal Voltage 12 V
- Rated Capacity 9,000 mAh
- Max Discharge Current 25 A

- Can be used with all GE BP and GE BTP models
- Easy connection to the inflators
- Can be inserted in the bag supplied with GE BP and GE BTP models
- Battery charger included (120V / 230V)



SP Z149 - R990062  
 CONNETTORI PER BP12 E BTP12 (6130037N - 6130038N)  
 CONNECTORS FOR BP12 E BTP12 (6130037N - 6130038N)

Item	Part number
SL BATTERY	K6131295

Tutti i manuali di istruzione dei gonfiatori elettrici sono scaricabili dal sito [www.scoprega.it](http://www.scoprega.it)

# BATTERIA AGLI IDRURI DI NICHEL

- Batteria al NI-MH ricaricabile
- Capacità 10'000 mAh
- Voltaggio 12V
- Massima corrente di scarica 25 A

- Applicabili a tutte le versioni GE BP e GE BTP
- Connessione facilitata ai gonfiatori
- Inseribile nella sacca fornita con GE BP e GE BTP
- Carica batteria (120V / 230V) compreso

- NiMH Rechargeable Battery
- Nominal Voltage 12V
- Rated Capacity 10'000 mAh
- Max Discharge Current : 25 A

- Can be used with all GE BP e GE BTP models
- Easy connection to the inflators
- Can be inserted in the bag supplied with GE BP and GE BTP models
- Battery charger included (120V / 230V)



SP Z149 - R990062  
 CONNETTORI PER BP12 E BTP12 (6130037N - 6130038N)  
 CONNECTORS FOR BP12 E BTP12 (6130037N - 6130038N)

Item	Part number
HP BATTERY	K6131290

All instruction manuals can be downloaded on [www.scoprega.it](http://www.scoprega.it)



# POMPE ELETTRICHE 12V

12V ELECTRIC PUMPS

## BST

- Nuova generazione della gamma BST
- Ridotto consumo di corrente
- Maggiore affidabilità
- BST 800 BATTERY: carica batteria disponibili come optional (230/120V - R990035)
- Forniti con borsetta a tracolla e completi di raccordi per tutte le più comuni valvole
- Lunghezza tubo 1,70m

- New upgrade of BST range
- Reduced current consumption
- Higher reliability
- BST 800 BATTERY: the battery chargers are available as an option (230/120V - R990035)
- Supplied with carry-bag and adapters for the most common valves
- Hose length 1,70m



### MANUALE/ INSTRUCTION MANUAL

Item	BST 800	BST 800 BATTERY	BST 300
Part number	6130132	6130134	6130131
Air flow	450 l/min	450 l/min	450 l/min
Max. Pressure	800 mbar (11.6 psi)	800 mbar (11.6 psi)	300 mbar (4.4 psi)
Current consumption	13 A	13 A	13 A
Inflate mode	TURBINE + PISTONS	TURBINE + PISTONS	TURBINE + PISTONS
Inflate-deflate	INFLATE and DEFLATE	INFLATE and DEFLATE	INFLATE and DEFLATE
Voltage supply	12V DC from alligators	12V DC from integrated lead battery	12V DC from cigarette plug or alligators
Dimensions	18 x 20 x 24 cm	18 x 20 x 30 cm	18 x 20 x 24 cm
Weight	1.9 kg	4.8 kg	1.9 kg
Suitable for	BOATS, KITES, KAYAKS, ALL INFLATABLES	BOATS, KITES, KAYAKS, ALL INFLATABLES	BOATS, KITES, KAYAKS, ALL INFLATABLES

Tutti i manuali di istruzione dei gonfiatoi elettrici sono scaricabili dal sito [www.scoprega.it](http://www.scoprega.it)



BST 300 - BST 800

All instruction manuals can be downloaded on [www.scoprega.it](http://www.scoprega.it)



# POMPE ELETTRICHE 12V E 24V

12V AND 24V ELECTRIC PUMPS

## TURBO MAX

Gonfiatore a 12V o 24V capace di gonfiare i maxi gommoni in pochissimi minuti.

- Pressione regolabile fra 175 e 250 mbar con ARRESTO AUTOMATICO
- Cavo ad alto rendimento di 1,70 metri
- Tubo di 2,8 metri con diametro maggiorato (Ø 25 mm)
- Fusibile di sicurezza
- Gonfia e sgonfia
- Molto flessibile: può gonfiare grosse camere e piccoli oggetti

*This 12V or 24V inflator can inflate large rubber dinghies in a few minutes.*

- Pressure can be regulated from 175 to 250 mbar with AUTOMATIC SHUTOFF
- High performance 1,70 meter cable
- Tube with increased diameter (Ø 25 mm), 2,8 meter long
- Safety fuse
- Inflates and deflates
- Very flexible: it can inflate large chambers and small objects

MANUALE/ INSTRUCTION MANUAL (12V) 

MANUALE/ INSTRUCTION MANUAL (24V) 

Item	Part number	Dimensions	Power supply	Current consumption	Air Flow	Max Pressure
TURBO MAX 12V	6130022	31x18 x h 19 cm	12V DC	45-60A max	1000 l/min	250 mbar (3.6 psi)
TURBO MAX 24V/S	6130072	31x18 x h 19 cm	24V DC	23-30A max	1000 l/min	250 mbar (3.6 psi)



## TURBO MAX KIT

SCOPREGA TURBOMAX 24V-EV garantisce affidabilità e funzionalità di alto livello. L'unità ha un driver integrato digitale sviluppato con DSP e tecnologie MOSFET controllate da un microprocessore. Il TURBOMAX ha due potenti motori che permettono grandi portate e si spengono automaticamente una volta raggiunta la pressione impostata.

- Tensione d'ingresso: 21-31 VDC
- Corrente d'ingresso: 25 A (Continua), 30 A (Picco)
- Portata: 1000 L/min
- Pressione 250 mbar (3.6 psi)
- Cavo ad alto rendimento di 0,5 metri

SCOPREGA Turbomax 24V-EV stands alone for reliability and function. The unit has integrated a digital DC servo- Drive developed with DSP and high efficient MOSFET technologies controlled by a microprocessor. The Turbomax has two powerful motors and when the pump starts it will be on a high volume twin pump (turbine) until it reaches the required pressure. Once reaching the set pressure it will automatically switch off.

- Input Voltage: 21-31 VDC
- Input Current: 25 A (Cont.), 30 A (Peak)
- Capacity: 1000 L/min
- Pressure: 250 mbar (3.6 psi)
- High performance 0,5 meter cable



- Nella versione KIT per montaggio fisso vengono fornite le viti e staffe di montaggio
- Non viene fornita la borsa. Il cavo di alimentazione è lungo 0,50 mt con connettore da 100 A cablato
- Il tubo viene fornito su richiesta in bobine da 25 mt, raccordi per valvole inclusi (SP Z031 - R21 1002)

*- In the KIT for permanent installation version, the screws, brackets, and inflation connectors are standard supplied.*

*- The bag is not supplied. The power cable is 0,5 m long and has a 100 A CONNECTOR cabled.*

*- The tube is supplied on demand in 25 m reels (SP Z031 - R21 1002).*

Item	Part number
TURBO MAX KIT 12V	6130021
TURBO MAX KIT 24V-EV	6130076

# ACCESSORI 12V/24V

ACCESSORIES FOR 12V/24V



- Connettore maschio/femmina adatto per apparecchi con potenza fino a 100 A 12 V DC
- Il kit consente di cablare cavi da 5 a 10 mm<sup>2</sup>
- Dimensioni: 10 x 3 x 3 cm

- Male/female connector suitable for equipment with power up to 100 A 12 V DC
- The kit allows cabling cables from 5 to 10 mm<sup>2</sup>
- Dimensions: 10 x 3 x 3 cm



- Consente il montaggio del TURBO MAX KIT a filo plancia
- Protegge il gonfiatore da spruzzi e sporco
- Corpo in nylon, coperchio in materiale trasparente
- Dimensioni sportello fuori plancia 34,5 x 22 x 1,8 cm (profondità dentro la plancia 13 cm)

- Allows the installation of the TURBO MAX KIT flush with the deck
- Protects the inflator from sprays and dirt
- Nylon body, transparent cover
- Dimensions of the cover out of the deck: 34,5 x 22 x 1,8 cm (depth inside the deck 13 cm)



- Tubo di gonfiaggio con adattatori
- Hose for TURBO MAX 25 m/ø 25 mm - EPDM

<b>Part number</b>	R401159	K6130024	R211002
<b>Description</b>	CONNETTORE PER TURBO MAX CONNECTOR FOR TURBO MAX	CONTENITORE TURBO MAX TURBO MAX BOX	SP Z031 - Tubo per TURBO MAX 25 m/ø 25 mm - EPDM Hose for TURBO MAX 25 m/ø 25 mm - EPDM

Tutti i manuali di istruzione dei gonfiatori elettrici sono scaricabili dal sito [www.scoprega.it](http://www.scoprega.it)

# POMPE ELETTRICHE 230V - IP65

ELECTRIC PUMPS 230V - IP65

## GE 2000-65

Gonfiatore professionale 230V, IP65. Adatto al gonfiaggio/sgonfiaggio di grandi strutture gonfiabili senza controllo di pressione. Presa Schuko IP68



- SP Z032 - Art. 850**  
Part number R211003 - EPDM
- SP Z033 - Art. 860**  
Part number R211004 - PVC

Tubo Ø 40 mm x 15 mt., alte prestazioni, per gonfiatori PCS, GE 230/2000 A.R.S./MIL, ed OV10-40.

Ø 40 mm x 15 mt inflation hose, high performance, for pumps PCS, GE 230/2000 A.R.S./MIL, and OV10-40.



Provisto di portagomma 25/40mm  
Equipped with adapter 25/40mm

MANUALE/ INSTRUCTION MANUAL

<b>Item</b>	GE 2000 - 65
<b>Part number</b>	K6131100
<b>Voltage supply</b>	210-240 V AC; 50 cycles
<b>Max power</b>	2500 W
<b>Max current consumption</b>	16A
<b>Max preset pressure (Inflate and hold)</b>	550 mbar (8.0 psi) (No pressure control)
<b>Min preset pressure (Inflate and hold)</b>	
<b>Max flow rate (zero pressure)</b>	2800 l/min
<b>Dimensions</b>	70 x 25 x 35 cm
<b>Weight</b>	15 Kg
<b>Protection degree</b>	IP65 according to IEC standard 60529
<b>Pressure sensor cable length</b>	10 meters

All instruction manuals can be downloaded on [www.scoprega.it](http://www.scoprega.it)





# POMPE ELETTRICHE 230V - IP65

ELECTRIC PUMPS 230V - IP65

## PCS - PRESSURE CONTROL SYSTEM

Il PCS è un sistema in grado di mantenere la pressione nominale all'interno di grandi strutture gonfiabili entro valori definiti (min. 90 mbar, max. 450 mbar), indipendentemente dalla temperatura ambiente.

Attraverso un sensore elettronico di pressione, l'unità monitora costantemente la variazione di pressione all'interno della struttura gonfiabile

e regola automaticamente le fasi di gonfiaggio e sgonfiaggio, mantenendo costante il valore nominale definito.

In caso di temporanea mancanza di potenza, il sistema PCS si riavvia autonomamente mantenendo tutti i valori preimpostati.

Fornito senza tubo di gonfiaggio, acquistabile separatamente

Protezione termica integrata

Range di utilizzo: -10°C/+60°C

Preso Schuko IP68

*The PCS is a system able to keep the nominal pressure inside a large inflatable structures within pre-set values (min. 90 mbar, max. 450 mbar), independently from ambient temperature.*

*The unit constantly monitors the pressure variation inside the inflatable structure and regulates the operation to ensure pressure top-up and pressure relief through electronic pressure sensor.*

*In case of temporary lack of power, PCS keeps all pre-set values and will re-start as soon as the power is back.*

*Supplied without inflation hose, purchasable separately*

*Integrated thermal protection*

*Working temperature range: -10°C/+60°C*

*Schuko plug IP68*

### MANUALE/ INSTRUCTION MANUAL

<b>Item</b>	PCS - Pressure Control System
<b>Part number</b>	6130650
<b>Voltage supply</b>	210-240 V AC; 50 cycles
<b>Max power</b>	2500 W
<b>Max current consumption</b>	16A
<b>Max preset pressure (Inflate and hold)</b>	450 mbar (6.5 psi) (factory set)
<b>Min preset pressure (Inflate and hold)</b>	90 mbar (1.3 psi) (factory set)
<b>Max flow rate (zero pressure)</b>	2800 l/min
<b>Dimensions</b>	70 x 25 x 35 cm
<b>Weight</b>	16 Kg
<b>Protection degree</b>	IP65 according to IEC standard 60529
<b>Pressure sensor cable length</b>	10 meters



Provisto di portagomma 25/40mm  
Equipped with adapter 25/40mm

**SP Z032 - Art. 850**

**Part number R211003 - EPDM**

**SP Z033 - Art. 860**

**Part number R211004 - PVC**

Tubo Ø 40 mm x 15 mt., alte prestazioni, per gonfiatori PCS, GE 230/2000 A.R.S./MIL, ed OV10-40.

Ø 40 mm x 15 mt inflation hose, high performance, for pumps PCS, GE 230/2000 A.R.S./MIL, and OV10-40.

# GE 230/2000 A.R.S.

A.R.S. Automatic Refilling System

È un sistema di gonfiaggio e sgonfiaggio completamente automatico che consente di mantenere la pressione di grandi strutture gonfiabili entro un certo intervallo impostabile e comunque tra minimo 50 e massimo 350 mbar (0.7 / 5.8 psi).

- Dotata di due motori
- Gonfia e sgonfia, rabbocca e scarica la sovrappressione
- Completamente automatico (accensione e spegnimento)
- Cavo: 3 metri
- Peso: 5 Kg
- Con spina Schuko IP68

*It is a fully automated inflating /deflating system able to keep the pressure of big air structures within an adjustable range.*

*This pressure range can be set between 50 and 350 mbar (0.7 /5.1 psi).*

- Equipped with two engines
- Inflates and deflates
- It automatically switches on/off to keep the pressure
- Cord: 3 m
- Weight: 5 Kg
- With IP68 Schuko plug



Provisto di portagomma 25/40mm  
Equipped with adapter 25/40mm

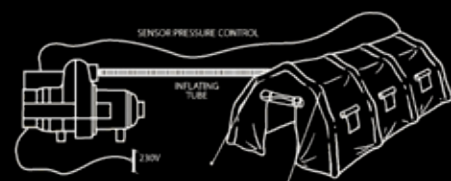

MANUALE/ INSTRUCTION MANUAL

Item	Part number	Dimensions	Power	Weight	Air Flow	Max Pressure	Voltage supply
GE 230/2000 A.R.S.	K6131090	40 x 17 x 26 cm	2000 W	5.00 kg	2000 l/min	50/350 mbar (0.7/5.1 psi)	230V AC



# ACCESSORI

ACCESSORIES FOR PCS - GE 230/2000 ARS/MIL - GE OV10-40 230V/120V



**SP Z032 - Art. 850**

**Part number** R211003 - EPDM

**SP Z033 - Art. 860**

**Part number** R211004 - PVC

Tubo Ø 40 mm x 15 mt., alte prestazioni, per gonfiatori PCS, GE 230/2000 A.R.S./MIL, ed OV10-40.

Ø 40 mm x 15 mt inflation hose, high performance, for pumps PCS, GE 230/2000 A.R.S./MIL, and OV10-40.



**SP Z034 - Art. 866**

**Part number** R211005

Tubo di controllo pressione PU Ø 6 mm x 15 mt. per gonfiatori GE 230/2000 A.R.S.

Pressure sensor hose PU Ø 6 mm x 15 mt. for pumps GE 230/2000 A.R.S.



**SP 156**

**Part number** R151023N

(per valvole tipo HR - for HR valves)

**SP 157**

**Part number** R151024N

(per valvole tipo H3 e BRAVO 2005 - for H3 and BRAVO 2005 valves)

Raccordo da 6 mm per collegare il tubo di controllo pressione alla valvola della struttura da gonfiare.

SOLO PER GE 230/2000 ARS

6 mm valve adapter to connect the pressure sensor hose to the valve of the structure to be inflated.

ONLY FOR GE 230/2000 ARS



**SP Z030 - Art. 790**

**Part number** R211001

Fascetta stringitubo Ø 25 mm in acciaio inox

Ø 25 mm stainless steel hose-collar

SP Z037 - Art. 785

**Part number** R211008

Fascetta stringitubo Ø 40 mm in acciaio inox

Ø 40 mm stainless steel hose-collar



**SP Z027 - Art. 760**

**Part number** R210035

Raccordo tubo-valvola da Ø 40 mm per VALVOLA BRAVO 260 H.V. (vedi pag. 84)

Abbinabile ai gonfiatori OV10-40 - GE 230/2000 A.R.S./MIL

Ø 40 mm hose-valve fitting for valve BRAVO 260 H.V. (see pag.84)

Suitable for inflators OV10-40 - GE 230/2000 A.R.S./MIL



**SP Z026 - Art. 795**

**Part number** R210034

Riduzione in PVC tubo-raccordo Ø 25/20 mm

PVC reduction hose/fitting TØ 25/20 mm



**SP Z135**

**Part Number** R151136

Adattatore 40/25 mm per collegare tubi da Ø 40 mm (es: GE OV10-40) con raccordi da 25 mm (es: R210030 / R210031). Il raccordo è da avvitare nell'articolo R210035.

Adapter 40/25 mm to connect Ø 40 mm hoses (es: GE OV10-40) to 25 mm fittings (es: R210030 / R210031). The adapter must be screwed into the item R210035.



**SP Z134**

**Part Number** R151134

Raccordo Tubo-Pompa a Y per gamma gonfiatori GE 230/2000 A.R.S./MIL / OV 10-40 compatibile con portagomma da Ø 25mm (R210033) e da Ø 40 mm (R210032)

Hose-Pump Y fitting for pumps GE 230/2000 A.R.S./MIL / OV 10-40 suitable to hose-fittings Ø 25 mm (R210033) and Ø 40 mm (R210032)



# POMPE ELETTRICHE 230V/120V

230V/120V ELECTRIC PUMPS

## GE 230/2000 - GE 120/2000

Il gonfiatore GE 2000 è composto da un motore principale e da uno supplementare (booster) che aumenta la portata e la pressione. I due motori possono funzionare contemporaneamente ed ottenere la massima portata e pressione, oppure il solo motore principale. Premere tasto arancio per il motore principale e all'occorrenza il tasto rosso che accende il booster per ottenere le prestazioni massime. Entrambi i motori sono protetti da fusibili termico-ampereometrici.

- cavo: 3 m
- Gonfia e sgonfia
- range di utilizzo: -10° C / +40° C
- Con spina Schuko

*GE 2000 consists of a main motor and a supplementary (booster) motor, which increases the capacity and pressure. The two motors can run simultaneously to obtain maximum capacity and pressure, or just the main motor. Press the orange button for the main motor and if necessary the red button that switches on the booster to obtain maximum performance. Both motors are protected by thermal-ampere fuses.*

- cord: 3 m
- Inflates and deflates
- temperature range: -10° C / +40° C
- With Schuko plug

## GE 230/2000 MIL

Modello speciale per esercito e gruppi di soccorso. Costruito con materiali plastici particolarmente resistenti agli urti e all'usura ed equipaggiato con:

- Tubo di grande diametro
- Un cavo di alimentazione rinforzato di 7 m e spina di sicurezza
- Con spina Schuko IP68

*Special version for army and rescue teams*

*Manufactured with high shock resistance compounds and equipped with:*

- Tube of big diameter
- A 7 m reinforced supply cable and a safety plug
- With IP68 Schuko plug

MANUALE/ INSTRUCTION MANUAL 

Item	Part number	Dimensions	Power	Weight	Air Flow	Max Pressure	Voltage supply
GE 230/2000	K6131000	32x17xh26cm	1000 W 2000 W	4.1 Kg	1200 l/min 2000 l/min	140 mbar (2.0 psi) 350 mbar (5.1 psi)	230V mainmotor 230V booster
GE 120/2000	K6131040	32x17xh26cm	1000 W 2000 W	4.1 Kg	1200 l/min 2000 l/min	140 mbar (2.0 psi) 350 mbar (5.1 psi)	120V mainmotor 120V booster
GE 230/2000 MIL	K6131050	32x17xh26cm	1000 W 2000 W	4.1 Kg	1200 l/min 2000 l/min	140 mbar (2.0 psi) 350 mbar (5.1 psi)	230V mainmotor 230V booster



## GE 230/1000

Gonfiatori elettrici professionali studiati per gli operatori del settore: fabbricanti di gommoni, cantieri, riparatori e rivenditori.

Grande volume d'aria e pressione, in grado di portare in pressione ogni tipo di gommone e/o strutture gonfiabili in genere (tende da campo, etc.)

- Forniti con raccordi adatti per le più comuni valvole in commercio
- Possono gonfiare e sgonfiare
- Motori e ventole di grande efficienza ed affidabilità.

*Professional electric inflators designed for the sector's operators: boats manufacturers, building yards, repairers and sellers.*

*Air high volume and pressure, which is sufficient to reach the correct pressure in every kind of boat and/or inflatable structures in general (tents, etc.)*

- Provided with connectors for the most common valves
- Designed to inflate and to deflate
- Motors and fan system of great efficiency and reliability

## GE 230/1000 MIL

Modello speciale per esercito e gruppi di soccorso.

Costruito con materiali plastici particolarmente resistenti agli urti e all'usura ed equipaggiato con:

- Tubo di grande diametro
- Un cavo di alimentazione rinforzato di 7 m e spina di sicurezza
- Con spina industriale IP67

*Special version for army and rescue teams*

*Manufactured with high shock resistance compounds and equipped with:*

- Tube of big diameter
- A 7 m reinforced supply cable and a safety plug
- With IP67 industrial plug

MANUALE/ INSTRUCTION MANUAL 

Item	Part number	Dimensions	Power	Weight	Air Flow	Max Pressure	Voltage supply
GE 230/1000	6130190	Ø 16,5xh27cm	1100 W	3 Kg	1500 l/min	230 mbar (3.3 psi)	230V
GE 230/1000 MIL	6130210	Ø 16,5xh33cm	1100 W	3,8 Kg	2500 l/min	230 mbar (3.3 psi)	230V



SP Z115 - R210053

per sgonfiare - inserire sul **fondo**  
to deflate - to be attached on the **bottom**



# POMPE ELETTRICHE 230V/120V

230V/120V ELECTRIC PUMPS

## GE OV10-40

- Provisto di tubo di gonfiaggio in PVC Ø 40 mm x 1,5 mt con raccordo per valvola BRAVO 260 H.V. (per maggiori informazioni su valvola e raccordo, vedi pag. 84)

- Provisto di filtro anti-sabbia  
- Gonfia e sgonfia

- Equipped with PVC inflation hose Ø 40 mm x 1.5 mt with fitting for valve BRAVO 260 H.V.

(more info on valve and fitting at pag. 84)

- Equipped with anti-sand filter  
- Inflate/deflate



Raccordo tubo-valvola da Ø 40 mm per valvola BRAVO 260 H.V. Abbinabile ai gonfiatori OV10-40.  
Ø 40 mm hose-valve fitting for valve BRAVO 260 H.V.  
Suitable for inflators OV10-40.

SP Z027 - Art. 760  
Part number R210035



Raccordo Tubo-Pompa a Y per gamma gonfiatori OV 10-40 compatibile con portagomma da ø 25mm (R210033) e da ø 40 mm (R210032)

Hose-Pump Y fitting for pumps OV 10-40 suitable to hose-fittings ø 25 mm (R210033) and ø 40 mm (R210032)

SP Z134  
Part Number R151134



Raccordi per abbinare tubi da 25 mm o 40 mm ai gonfiatori BRAVO 2000 ed OV10/OV6

Hose fittings to combine Ø 25 mm or Ø 40 mm inflation hoses to the pumps OV10-40

SP Z025 - Art. 741  
Part number R210033 - 25 mm  
SP Z024 - Art. 740  
Part number R210032 - 40 mm



GE OV10



GE OV6



GE OV4

Item	Part number	Dimensions	Power	Weight	Air Flow	Max Pressure
GE OV10 - 230V	K6130400	15 x 16 x 17 cm	1000 W	1.7 Kg	1700 l/min	250 mbar (3.6 psi)
GE OV10 - 120V	K6130440	15 x 16 x 17 cm	1000 W	1.7 Kg	1700 l/min	250 mbar (3.6 psi)
GE OV6 - 230V	K6130430	15 x 16 x 17 cm	600 W	1.3 Kg	1600 l/min	175 mbar (2.5 psi)
GE OV4 - 230V	K6130415	12 x 15 x 14.5 cm	400 W	0.9 Kg	950 l/min	150 mbar (2.2 psi)

MANUALE/ INSTRUCTION MANUAL 

MANUALE/ INSTRUCTION MANUAL 

Item	Part number	Dimensions	Power	Weight	Air Flow	Max Pressure
GE OV10-40 - 230V	K6130450	15 x 16 x 17 cm	1000 W	1,7 Kg	2000 l/min	250 mbar (3.6 psi)
GE OV10-40 - 120V	K6130495	15 x 16 x 17 cm	1000 W	1,7 Kg	2000 l/min	250 mbar (3.6 psi)

# POMPE A MANO

HAND PUMPS

## BRAVO 100 - BRAVO 101 - BRAVO 110

Nuova generazione di gonfiatori manuali per tutti i tipi di prodotti gonfiabili

- Soluzioni innovative garantiscono alta efficienza e semplicità di utilizzo
- Commutazione manuale flusso doppio/singolo
- Il design e l'ingegneria innovativa permettono di gonfiare più velocemente e con meno sforzo di qualsiasi altra pompa presente sul mercato
- Maniglia ergonomica

- Base allargata per massima stabilità
- Manometro integrato
- La bocca di gonfiaggio installata sul corpo pompa permette al tubo di mantenersi fermo durante l'utilizzo
- Filtro protettivo integrato
- Raccordi di gonfiaggio per tutte le più comuni valvole
- Corda per l'aggancio al kite fornita con BRAVO 101 / BRAVO 110
- Sacca a tracolla e scatola litografata disponibili come optional



BRAVO 100

BRAVO 101

BRAVO 110

Tutti i manuali di istruzione dei gonfiatori elettrici sono scaricabili dal sito [www.scoprega.it](http://www.scoprega.it)

## BRAVO 100-D

New generation of hand pumps for all kind of inflatable products.

- Innovative solutions grant high efficiency and easy-use
- Double/Single action
- Bravo New hand pump design allows to inflate faster and with less effort than any other pump in the market thanks to the unique architecture
- Ergonomic handle
- Enlarged base for maximum stability
- Built in pressure gauge
- Inflation port on pump body (no hose kinking)
- Protective filter
- Inflation fittings available for all most common valves
- Kite-leash available with BRAVO 101 / BRAVO 110
- Carry-bag and color box available (optional)



ADAPTERS - BRAVO 101 - 110 BRAVO 100 - 100D

### MANUALE/ INSTRUCTION MANUAL

Item	BRAVO 100	BRAVO 100-D	BRAVO 101	BRAVO 110
<b>Part number</b>	6120500	K6120540	6120600	6120720 (grigio/grey)
<b>Capacity</b>	2 x 2000 cc	2 x 2000 cc	2 x 1500 cc	2 x 2500 cc
<b>Max. Pressure</b>	1,9 bar (27.5 psi)	1,9 bar (27.5 psi)	1,9 bar (27.5 psi)	1 bar (14.5 psi)
<b>Inflate mode</b>	DOUBLE/SINGLE ACTION	DOUBLE/SINGLE ACTION	DOUBLE/SINGLE ACTION	DOUBLE/SINGLE ACTION
<b>Inflate-deflate</b>	INFLATE ONLY *	INFLATE and DEFLATE	INFLATE ONLY *	INFLATE and DEFLATE
<b>Dimensions</b>	14 x 30 x 65 cm	14 x 30 x 65 cm	14 x 30 x 57 cm	17 x 30 x 58 cm
<b>Construction</b>	ABS + ALUMINUM	ABS + ALUMINUM	ABS + ALUMINUM	ABS + ALUMINUM
<b>Suitable for</b>	SUP BOARDS	SUP BOARDS	KITES, SUP, BOATS, KAYAKS, ALL INFLATABLES	KITES, BOATS, KAYAKS, TENTS, ALL INFLATABLES

All instruction manuals can be downloaded on [www.scoprega.it](http://www.scoprega.it)



# GM 110 MIL

IMPUGNATURA IN ACCIAIO INOX  
STAINLESS STEEL HANDLE

MOLLA DI ARRESTO  
STOP SPRING

Modello speciale per esercito e gruppi di soccorso, costruito con materiali plastici e metallici resistenti agli urti ed all'usura.

- Commutazione manuale flusso doppio/singolo
- La bocca di gonfiaggio installata sul corpo pompa permette al tubo di mantenersi fermo durante l'utilizzo
- Manometro integrato, filtri protettivi integrati
- Gonfia e sgonfia
- Raccordi di gonfiaggio per tutte le più comuni valvole

Special version for army and rescue teams, manufactured with plastic and metal high shock resistance components

- Double/Single action (manual commutation by lever switch)
- Inflation port on pump body (no hose kinking)
- Built in pressure gauge and protective filters
- Inflates and deflates
- Inflation fittings available for all most common valves

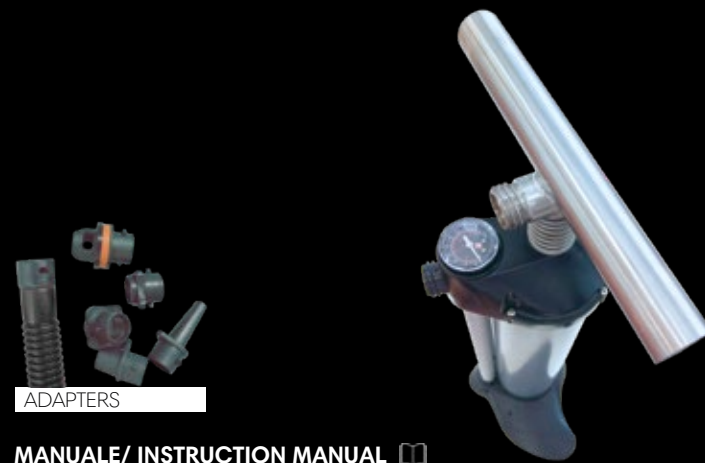

ADAPTERS

MANUALE/ INSTRUCTION MANUAL

Item	Part number	Dimensions	Capacity	Max Pressure
GM 110 MIL	K6120750	17 x 30 x h 60 cm	2x2500 cc	1,0 bar (14.5 psi)



# POMPE A MANO

HAND PUMPS

## BRAVO 6



- Pompa a doppio flusso
- Corpo in ABS
- Double-action pump
- Body made of ABS

Item	Part number	Dimensions	Capacity	Max Pressure
BRAVO 6	6120006	21 x 12 x 47 cm	2x2500 cc	600 mbar (8.7 psi)
BRAVO 6 M	6120007	21 x 12 x 47 cm	2x2500 cc	600 mbar (8.7 psi)

IMPORTANTE

Togliendo il tappo la pompa diventa a flusso semplice, consentendo di gonfiare alla massima pressione con sforzo limitato.

IMPORTANT

BRAVO 6 can be transformed in a single action pump by removing this plug. In this case the pump will work while pushing only, thus reducing the physical effort needed to inflate at the high pressure.

## BRAVO 6M



BRAVO 6 M  
con manometro  
1,0 bar - 14.5 psi  
with pressure gauge  
1,0 bar - 14.5 psi



# POMPE A MANO

HAND PUMPS

## GM 4 XS

Nuova pompa a mano compattabile per ottenere un minimo ingombro nel trasporto/stoccaggio

- Soli 45 cm di altezza
- Base pieghevole, facile da confezionare e trasportare
- Maniglia riducibile svitandone le estremità
- Manometro integrato sulla maniglia
- Commutazione manuale flusso doppio / flusso singolo
- Fornita con raccordi di gonfiaggio per tutte le più comuni valvole

New hand pump with reducible dimensions for space-saving in shipping/storage

- Only 45 cm height
- Foldable base, easy to pack and transport
- Reducible handle
- Built-in pressure gauge
- Manual commutation double/single action (lever switch)
- Supplied with fittings for the most common valves

<b>Item</b>	<b>GM 4 XS</b>
<b>Part number</b>	6120970N
<b>Capacity</b>	2x1100cc
<b>Max. Pressure</b>	2.0 bar (29 psi)
<b>Inflate mode</b>	INFLATE - DEFLATE
<b>Dimensions</b>	10,5 x 26,5 x 45 cm - 10,5 x 15 x 45 cm



MANIGLIA E BASE COMPATTABILI - FOLDABLE HANDLE AND BASE

SWITCH DOPPIO/SINGOLO FLUSSO - DOUBLE SINGLE ACTION SWITCH



# POMPE A MANO

HAND PUMPS

## GM 4 WD

- Base pieghevole, facile da confezionare e trasportare
- Manometro posizionato sulla base, stabile e anti shock
- Nuovo sistema di gonfiaggio, per un grande volume e un gonfiaggio veloce
- La bocca di gonfiaggio installata sulla base permette al tubo di mantenersi fermo durante l'utilizzo
- Sacca a tracolla disponibile come optional
- Filtro anti sabbia integrato

- Foldable foot base, easy to pack and transport
- Pressure gauge on the base, stable and anti-shock
- New inflate system design, for a big volume and a fast inflation
- Inflation port on base (no hose kinking)
- Carry-bag available (optional)
- Sand filter integrated



<b>Item</b>	GM 4 WD
<b>Part number</b>	61 20900N
<b>Capacity</b>	1 x 2200 cc
<b>Max Pressure</b>	1,0 bar (14.5 psi)
<b>Inflate mode</b>	SINGLE ACTION
<b>Inflate-deflate</b>	INFLATE - DEFLATE
<b>Dimensions</b>	19.5 x 15 x 58.5 cm
<b>Suitable for</b>	KITES, SUP, BOATS, KAYAKS, TENTS ALL INFLATABLES

## GM 4 - GM 4 ALU

- Pompa a mano doppio flusso
- Protezione anti sabbia
- Gonfia e sgonfia
- Adatta per gommoni, kayak e kite

- Double-action hand pump
- Anti-sand cover gasket
- It inflates and deflates
- Suitable for inflatable boats, kayaks and kites

### GM 4



Item	Part number	Dimensions	Capacity	Max Pressure
GM 4	61 20960N	11 x 22 x 45 cm	2x2000 cc	500 mbar (7.2 psi)
GM 4 ALU	61 20940N	11 x 22 x 47 cm	2x2000 cc	800 mbar (11.6 psi)
GM 4 ALU (in PE bag)	61 20950N	11 x 22 x 47 cm	2x2000 cc	800 mbar (11.6 psi)

### GM 4 ALU

R.E.D. Reduced Effort Device

Conversione automatica da flusso doppio a flusso singolo oltre i 400 mbar per ridurre lo sforzo a pressioni più elevate

Automatic switch from double action into single action over 400 mbar in order to reduce the effort at higher pressure



Optional  
SP 90 B - R551093N  
0-1 bar (0-14.5 psi)

# POMPE A PEDALE

FOOT PUMPS

- Fascia in tessuto rinforzato
- Parti metalliche in acciaio inox
- Adattatore universale
- Reinforced fabric coated bellows
- All stainless steel metal parts
- Universal adaptor

## BRAVO 1



Item	Part number	Dimensions	Capacity	Max Pressure
BRAVO 1	6070001	26 x 20 x h 8 cm	4 L	500 mbar (7.2 psi)

## GP 5

- Gonfiatore a pedale ad alte prestazioni
- Raccordi di gonfiaggio per tutte le più comuni valvole
- High performance foot pump
- Inflation fittings available for the most common valves



Item	Part number	Dimensions	Capacity	Max Pressure
GP 5	K6080000	29 x 22 x 8 cm	5 L	400 mbar (5.8 psi)



# POMPE A PEDALE

FOOT PUMPS

## POMPA A DOPPIA CAMERA

Il gonfiatore GP 10, grazie alla doppia camera, consente di raggiungere senza sforzo la pressione raccomandata per tutti i grossi canotti in tessuto o in gomma.

Il gonfiatore GP 10 è dotato di un indicatore visivo di pressione per segnalare l'eccessivo gonfiaggio del canotto, se l'utilizzatore non controlla la pressione con l'apposito manometro.

- Robusto, essendo in nylon caricato vetro
- Inalterabile al sole e all'ambiente marino
- Grande ma leggero, essendo di materiale plastico (Kg. 1,9)
- Stabile al suolo, grazie ai 4 piedini antiscivolo
- Dotato di un tubo indeformabile al calpestio

## DOUBLE CHAMBER PUMP

*With the GP 10 double chamber pump, inflation to the recommended pressure of all fabric or rubberised boats, can be easily achieved with a very limited effort.*

*Should you not use a pressure gauge to control the boat pressure, GP 10 footpump is provided with a visual pressure indicator to warn against over-inflation.*

- Manufactured from strong nylon reinforced fiberglass
- Unalterable by the sun or sea environment
- Big but lightweight due to the use of synthetic materials (Kg 1.9)
- 4 antislip feet for greater stability
- Standard crush-resistant hose

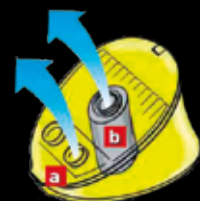

A  
Grande volume d'aria 5,5 L (bassa pressione)  
Pressione max 300 mbar (4.4 psi)

*High air volume (low pressure)  
Max pressure 300 mbar (4.4 psi)*

B  
Minor volume d'aria 1,6 L (alta pressione)  
Pressione max 800 mbar (11.6 psi)

*Lower air volume (high pressure)  
Max pressure 800 mbar (11.6 psi)*

MANUALE/MANUAL

Item	Part number	Dimensions	Capacity	Max Pressure
GP 10	6090010	35 x 25 x h 8 cm	5,5 L/1,6 L	300/800 mbar (11.6 psi)

# POMPE A PEDALE

FOOT PUMPS

## BRAVO 7M

- Fascia in tessuto rinforzato
- Parti metalliche in acciaio inox
- Adattatore universale
- Manometro incorporato a lettura progressiva della pressione

- Reinforced fabric coated bellows
- All stainless steel metal parts
- Universal adaptor
- Built-in pressure gauge meter to allow the instant reading of the pressure



Item	Part number	Dimensions	Capacity	Max Pressure
BRAVO 7M	6090017N	28 x 21 x h 6 cm	4 L	400 mbar (5.8 psi)

# BRAVO 9

## POMPA A DOPPIA CAMERA

Grande efficienza - Alta pressione fino a 800 mbar (11.6 psi).  
Gonfiatore a doppia camera con dispositivo che consente l'utilizzo ottimale della capacità di gonfiaggio sia dei tubolari che del fondo ad alta pressione.

Per gonfiare i tubolari si inizia a gonfiare con il tappo inserito, sfruttando appieno la capacità.

Per gonfiare il fondo, eseguire la stessa operazione come per i tubolari, quindi rimuovere il tappo. Automaticamente la pompa utilizza solo la camera più piccola, consentendo di raggiungere senza sforzo la pressione di 800 mbar (11.6 psi).  
Per tenere sotto controllo la pressione durante il gonfiaggio si consiglia di associare il manometro SP 125/1

## DOUBLE CHAMBER PUMP

High efficiency - high pressure up to 800 mbar (11.6 psi).

Double chamber with a device allowing the use of the optimal inflating capacity for both the tubes and the high-pressure floor.

To inflate the ribs, start inflating with the cap inserted, to completely exploit the capacity.

To inflate the bottom, follow the same procedure as for the tubulars, therefore remove the cap. The pump will use automatically the smaller chamber only, thus allowing to reach without effort the pressure of 800 mbar (11.6 psi).

It is recommended a SP125/1 pressure gauge to be used to monitor the pressure while inflating



Item	Part number	Dimensions	Capacity	Max Pressure
BRAVO 9	6090009N	32 x 23 x h 7 cm	6 L	800 mbar (11.6 psi)



02

# REMI E PAGAIE

OARS AND PADDLES





# REMI NAUTICI

OARS



Linee AP, RSP e RSPZ disponibili su richiesta con rosone montato per scalmi tipo 145 - 146.

AP, RSP and RSPZ lines are available on request with trim piece installed for types 145 - 146.

RSP 160 - RSP 180



RSP 140.Z - RSP 150.Z - RSP 16.Z

Item	Part number		Dimension	Diameter
	Black	Grey		
RSP 160		K6501501	160/84 cm	Ø35mmx1 mm
RSP 180	K6501600		180/84 cm	Ø35mmx1 mm
RSP 140.Z	K6501470	K6501471	140 cm	Ø35mmx1 mm
RSP 150.Z		K6501481	150 cm	Ø35mmx1 mm
RSP 160.Z	K6501490	K6501491	160 cm	Ø35mmx1 mm
RSP 160.ZK		K6501493	160 cm	Ø35mmx1 mm
RSP 180.K	K501602		180 cm	Ø35mmx1 mm

## ON DEMAND, ONLY

Item	Part number		Dimension	Diameter	MOQ
	Black	Grey			
RSP 160	K6501500		160/84 cm	Ø35mmx1 mm	108
RSP 160 K	K6501550		160/84 cm	Ø50mmx1 mm	108
RSP 160 ZK	K6501492		160/84 cm	Ø50mmx1 mm	108
RSP 150 Z		K6501480	150 cm	Ø35mmx1 mm	120
RSP 150 ZK	K6501482		150 cm	Ø40mmx1 mm	108
RSP 180		K6501601	180/84 cm	Ø50mmx1 mm	108
RSP 180 K		K6501603	180 cm	Ø60mmx1 mm	108
RSP 180 K		K6501606	180 cm	Ø54mmx1 mm	108

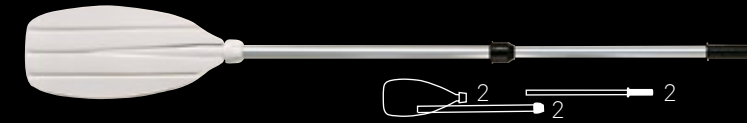

3715

Telescopico  
Telescopic

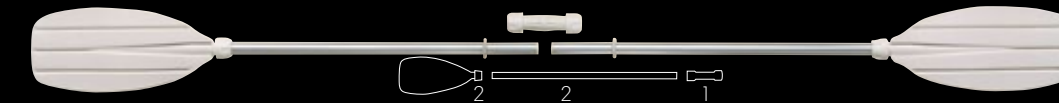

1410

Trasformabile in pagaia  
Transformable into paddle

A B

Item	Part number	Dimension	Diameter
3715 / SC	6201415N	120/160 cm Smontato/Disass = 70 cm	Ø 28/25 mm
1410/SC	6201421N	222 cm	Ø 28 mm

## ON DEMAND, ONLY

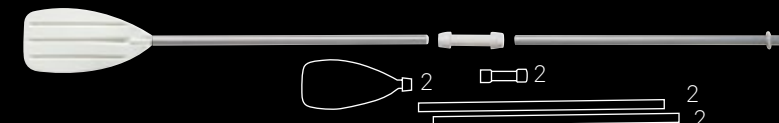

2035

Trasformabile in pagaia  
Transformable into paddle

A B

Item	Part number	Dimension	Diameter	MOQ
2035/ SC	6201221N	A 146 cm - B 217 cm	Ø 25 mm	300pcs

# REMI NAUTICI

OARS

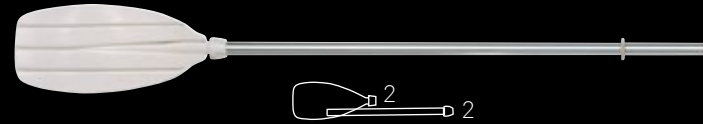

1400

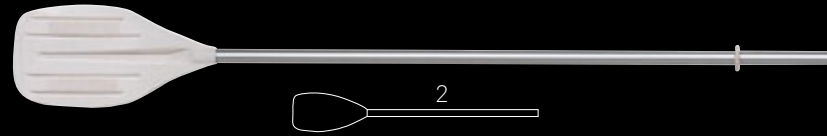

2010

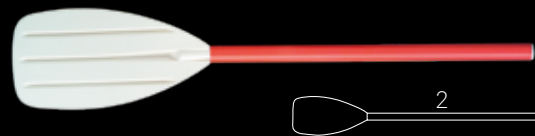

916



Per zattere di salvataggio  
For liferafts

Item	Part number	Dimension	Diameter
1400 / SC	6201401N	150 cm	Ø 28 mm
2010 / SC	6201111N	140 cm	Ø 25 mm
916 / SC	6942050N	82 cm	Ø 27 mm

# REMI E MEZZI MARINAI TELESCOPICI

TELESCOPIC OARS AND BOAT HOOKS



TSP 110/155



N100



IDS 16



Item	Part number		Dimension	Diameter
	Black	Grey		
TSP 110/155		6293101N	A + B + C = 158 cm A + B = 118 cm Smont./Disas. = 64 cm	Ø 30/35 x 1 mm
TSP 50/120	6293103N		A = 50 cm B = 120 cm	Ø 24/28 x 1 mm
N100	6281100N		120/180 cm	Ø 25/30 x 1 mm
IDS 16	6282200N		105/180 cm	Ø 25/30 x 1 mm

## ON DEMAND, ONLY

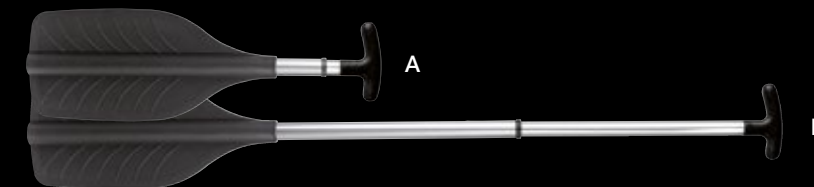

TSP 50/120

Item	Part number Grey	Dimension	Diameter	MOQ
TSP 50/120	6293104N	A = 50 cm B = 120 cm	Ø 24/28 x 1 mm	300 pcs

# PAGAIE PER KAYAK

KAYAK PADDLES

Manico in alluminio o fibra di vetro  
Alu or Fiberglass shaft

Sistema di impugnatura che consente, in ogni momento, di sapere com'è inclinata la pagaia.

Pala in polipropilene con 20% fibra di vetro  
Polypropilene blade with 20% fiberglass

Special handle system allowing to know, anytime, the paddle angle.

## ON DEMAND, ONLY



### KC FIBERGLASS-2

Peso/ Weight

1180 gr.

Colore/Color

Nero/Black



Connessione con 3 posizioni.

Connection with 3 positions.

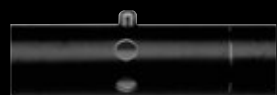

Manicotti in poliolefina termoretraibile.

Grip handle in shrinkable polyolefin



Item	Part number	Dimension	Diameter	MOQ
KC FIBERGLASS-2	6510200N	220 cm	Ø 29 x 1.2 mm	300pcs

# PAGAIE PER KAYAK

KAYAK PADDLES



Manico in fibra di vetro  
Fiberglass shaft

Pala in materiale extra strong con 40% fibra di vetro  
Extra strong plastic blade with 40% fiberglass.

210-240 cm



Lunghezza e orientamento regolabili tramite chiusura a leva  
Adjustable size and blade orientation by fast lever-lock system



Connessione con 3 posizioni.

Connection with 3 positions.



Sistema di impugnatura che consente, in ogni momento, di sapere com'è inclinata la pagaia. Manicotti in poliolefina termoretraibile.

Special handle system allowing to know, anytime, the paddle angle.

Grip handle in shrinkable polyolefin

Item	Part number	Dimension	Diameter
XT FIBERGLASS ADJ	6510700N	210-240 cm	Ø 29 x 1.2 mm
XT FIBERGLASS -2	6510610N	225 cm	Ø 29 x 1.2 mm

### XT FIBERGLASS ADJ

Colore/Color

Nero/Black

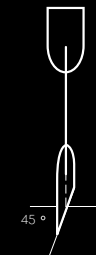

### XT FIBERGLASS -2

Colore/Color

Nero/Black





# PAGAIE PER KAYAK

KAYAK PADDLES

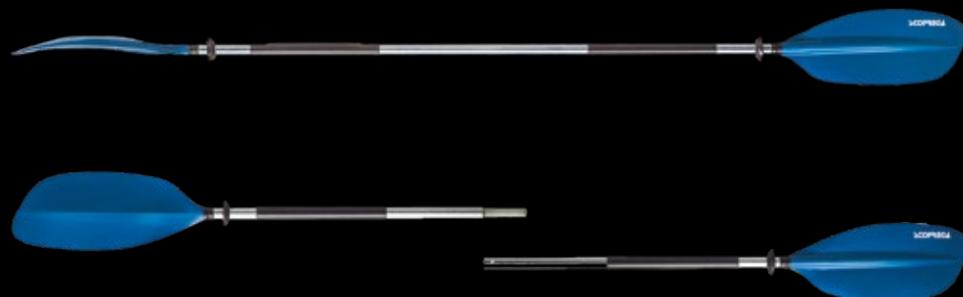

Manico in lega di alluminio 6005T5  
Alu. alloy 6005T5 shaft

Pala in polipropilene con 40% fibra di vetro  
Polypropilene blade with 40% fiberglass

Sistema di impugnatura che consente, in ogni momento, di sapere com'è inclinata la pagaia.

Special handle system allowing to know, anytime, the paddle angle.

Connessione con 3 posizioni.

Connection with 3 positions.

Manicotti in poliolefina termoretraibile.

Grip handle in shrinkable polyolefin

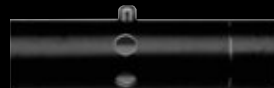

## XT ALU

Peso/ Weight

1050 gr.

In funzione della lunghezza  
According to the length

Colore/Color

Blu/Blue

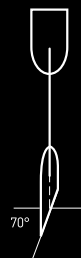

## XT ALU-2

Peso/ Weight

1150 gr.

In funzione della lunghezza  
According to the length

Colore/Color

Nero/Black



Item	Part number	Dimension	Diameter
XT ALU-2	6511110N	225 cm	Ø 29 x 1.2 mm
XT ALU ADJ	6511200N	210-240 cm	Ø 29 x 1.2 mm

## ON DEMAND, ONLY

Item	Part number	Dimension	Diameter	MOQ
XT ALU	6511000N	215 cm	Ø 29 x 1.2 mm	200pcs
	6511010N	225 cm	Ø 29 x 1.2 mm	200pcs
XT ALU-2	6511100N	215 cm	Ø 29 x 1.2 mm	200pcs

# PAGAIE PER KAYAK

KAYAK PADDLES



Manico in fibra di vetro.  
Fiberglass shaft.

Pala in materiale extra strong con 40% fibra di vetro.  
Extra strong plastic blade with 40% fiberglass.

Inaffondabili.  
All float for easy retrieval.



## KWB FIBERGLASS-2

Peso/ Weight

1000/1500 gr.

In funzione della lunghezza  
According to the length

Colore/Color

Nero/Black



Connessione con 3 posizioni.

Connection with 3 positions.

Sistema di impugnatura che consente, in ogni momento, di sapere com'è inclinata la pagaia.

Special handle system allowing to know, anytime, the paddle angle.



Manicotti in poliolefina termoretraibile.

Grip handle in shrinkable polyolefin

Item	Part number	Dimension	Diameter
KWB FIBERGLASS-2	6511620N	230 cm - L = 123 cm	Ø 29 x 1.2 mm

## ON DEMAND, ONLY

Item	Part number	Dimension	Diameter	MOQ
KWB FIBERGLASS-2	6511610N	220 cm - L = 118 cm	Ø 29 x 1.2 mm	200pcs



KWB FIBERGLASS ADJ

Colore/Color  
Nero/Black

Manico in fibra di vetro  
Fiberglass shaft

Pala in materiale extra strong con 40% fibra di vetro  
Extra strong plastic blade with 40% fiberglass.



Lunghezza e orientamento regolabili  
tramite chiusura a leva  
Adjustable size and blade orientation  
by fast lever-lock system

210-240 cm



Sistema di impugnatura che consente, in ogni momento, di sapere com'è inclinata la pagaia.

Manicotti in poliolefina termoretraibile.

Special handle system allowing to know, anytime, the paddle angle.

Grip handle in shrinkable polyolefin

Item	Part number	Dimension	Diameter
KWB FIBERGLASS ADJ	6511700N	210-240 cm	Ø 29 x 1.2 mm

# PAGAIE PER KAYAK

KAYAK PADDLES

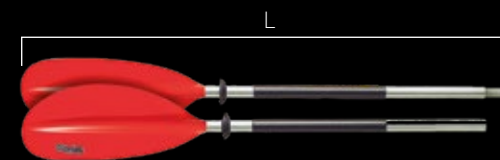

KWB ALU

Peso/ Weight  
1000/1090 gr.

In funzione della  
lunghezza  
According to the  
length

Colore / Color  
Rosso / Red

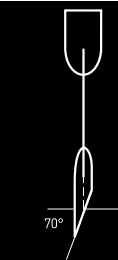

KWB ALU - 2

Peso/ Weight  
1040/1130 gr.

In funzione della  
lunghezza  
According to the  
length

Colore / Color  
Rosso / Red

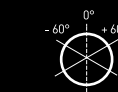

KWB ALU - 4

Peso/ Weight  
1040/1130 gr.

In funzione della  
lunghezza  
According to the  
length

Colore / Color  
Rosso / Red

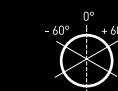

Item	Part number	Dimension	Diameter
KWB ALU	6512000N	210 cm	Ø 29 x 1.2 mm
KWB ALU-2	6512100N	220 cm - L = 118 cm	Ø 29 x 1.2 mm
KWB ALU-4	6512230N	230 cm - L = 77 cm	Ø 29 x 1.2 mm

Manico in lega di alluminio  
6005T5

Alu. alloy 6005T5 shaft

Pala in polipropilene con  
40% fibra di vetro.  
Polypropilene blade with  
40% fiberglass.

## ON DEMAND, ONLY

Item	Part number	Dimension	Diameter	MOQ
KWB ALU-2	6512110N	230 cm - L = 123 cm	Ø 29 x 1.2 mm	200pcs
KWB ALU-4	6512220N	220 cm - L = 72 cm	Ø 29 x 1.2 mm	200pcs



KWB ALU ADJ

Colore/Color  
Grigio/Grey



Manico in lega di alluminio 6005T5  
Alu. alloy 6005T5 shaft

Pala in polipropilene con 40% fibra di vetro  
Polypropilene blade with 40% fiberglass

210-240 cm



Lunghezza e orientamento regolabili  
tramite chiusura a leva  
Adjustable size and blade orientation  
by fast lever-lock system

Sistema di impugnatura che consente, in ogni  
momento, di sapere com'è inclinata la pagaia.

Manicotti in poliolefina termoretraibile.

Special handle system allowing to know,  
anytime, the paddle angle.

Grip handle in shrinkable polyolefin

Item	Part number	Dimension	Diameter
KWB ALU ADJ	6512300N	210-240 cm	Ø 29 x 1.2 mm

# PAGAIE PER KAYAK

KAYAK PADDLES



AK - PRO

Peso/ Weight  
1550 gr.



DPR 107

Peso/ Weight  
1350 gr.

Item	Part number	Dimension	Diameter
AK-PRO	6271300	210 cm	ALU Ø 32 x 1.2 mm
DPR 107	6519800N	210 cm	ALU Ø 30 x 1.2 mm

## ON DEMAND, ONLY



DPS



Item	Part number	Dimension	Diameter	MOQ
DPS	6519900N	210 cm	ALU Ø 29 x 1.0 mm	200pcs



# PAGAIE PER KAYAK - CANOE

KAYAK - CANOE PADDLES



DPR 107 KIT

KIT

- A) 1 x KAYAK = 220 cm  
B) 2 x CANOE = 150 cm

Item	Part number	Dimension	Diameter
DPR 107 KIT	6520100N	A 1 x KAYAK = 220 cm B 2 x CANOE = 150 cm	Ø 30 x 1.0 mm

## ON DEMAND, ONLY

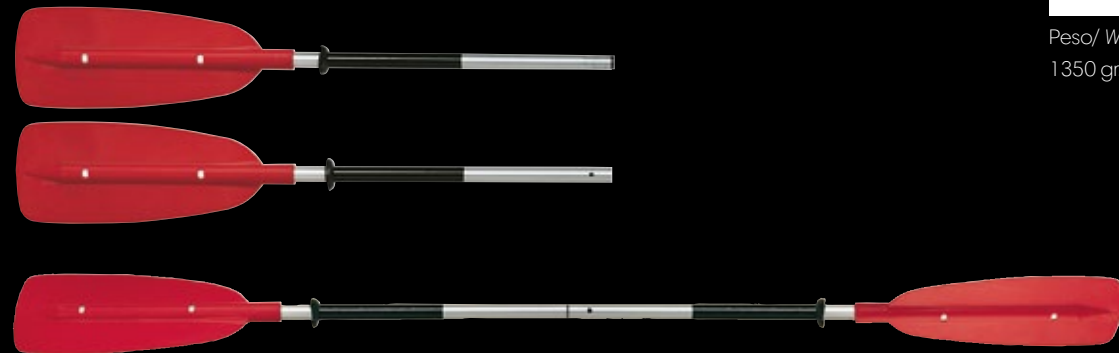

DPR 107 C

Peso/ Weight  
1350 gr.

Item	Part number	Dimension	Diameter	MOQ
DPR 107 C	6520000N	220 cm	Ø 30 x 1.0 mm	200pcs

# PAGAIE PER CANOE

CANOE PADDLES



RC PRO - KK PRO

Peso/ Weight  
950 gr.

Manico in alluminio lega 6005T5 con  
rivestimento plastico  
Pala in PP speciale antiurto

Aluminium alloy 6005T5 shaft with  
plastic coating  
Blade made of shock polypropilene

PR 105

Peso/ Weight  
850 gr.

PR 105 C

Peso/ Weight  
850 gr.

Item	Part number	Dimension	Diameter
RC PRO	6525010N	150 cm	Ø 29 x 1.2 mm
KK PRO	6273710N	140 cm	Ø 29 x 1.2 mm
PR 105	6525100N	140 cm	Ø 30 x 1.0 mm
	6525110N	150 cm	Ø 30 x 1.0 mm
	6525120N	160 cm	Ø 30 x 1.0 mm
PR 105 C	6525200N	150 cm Smont./Disass. = 88 cm	Ø 30 x 1.0 mm

# PAGAIE SUP

SUP PADDLES



- Pagaia regolabile con sistema "fast lever lock system"
- Lunghezza regolabile velocemente tramite chiusura a leva
- Pala con un nuovo design per performance più elevate
- Divisibile in tre parti per un pratico trasporto
- Doppio sistema di bloccaggio per una maggiore stabilità
- Trasformabile in una pagaia per ragazzi rimuovendo la sezione centrale del manico
- Galleggiante
- Adjustable size by fast lever lock system
- New design, lighter and sharper blade for higher performance
- Collapsible 3 parts, for easy packing and carrying
- Double lock system for more stability (no shake)
- Transformable in kid paddle by removing the central section
- 10 degree blade inclination, for faster and more efficient paddling experience
- Floatable

Item	Part number	Dimension	Diameter
SUP PADDLE ADJ 2018 - ALU	6531010N	175/215 cm	Ø 29 x 1.2 mm
SUP PADDLE ADJ 2018 - FIBERGLASS	6531020N	175/215 cm	Ø 29 x 1.2 mm

## ON DEMAND, ONLY



Item	Part number	Dimension	Diameter	MOQ
SUP PADDLE ADJ 2018 - CARBON	<b>6531000N</b>	175/215 cm	Ø 29 x 1.2 mm	200pcs

## ALU ADJ

Peso/ Weight  
1160 gr.

## FIBERGLASS ADJ

Peso/ Weight  
980 gr.



Lunghezza e orientamento regolabili  
tramite chiusura a leva  
Adjustable size and blade orientation  
by fast lever-lock system

## CARBON ADJ

Peso/ Weight  
890 gr.

## OARS AND PADDLES

## SUP PADDLE FIBERGLSS

Peso/ Weight  
950 gr.



## SUP PADDLE ALUMINIUM

Peso/ Weight  
1050 gr.

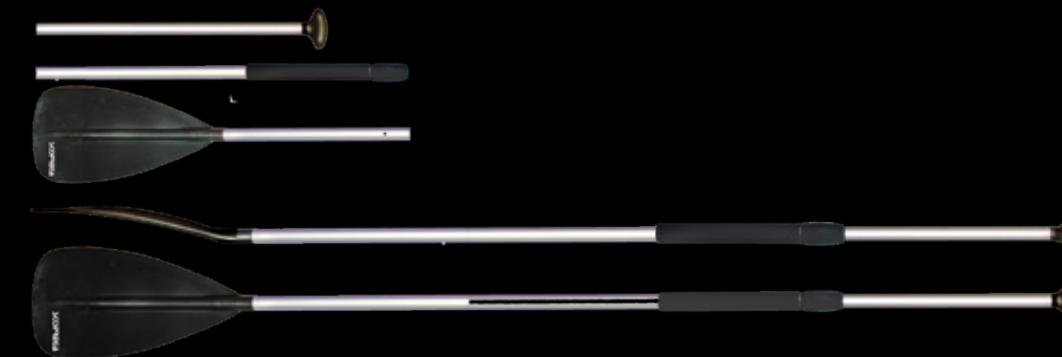

- Pagaia telescopica con regolazione rapida
- Regolabile da 170 a 215 cm
- Smontabile in 3 sezioni (ingombro max 86 cm)
- Disponibile con tubo in fibra di vetro e alluminio
- Pala in nylon caricato vetro 23x43 cm
- Leggera e professionale

- Quick adjustment telescopic paddle
- Adjustable from 170 to 215 cm
- Collapsible 3 parts (max dimension 86 cm)
- Available fiberglass shaft or alu shaft
- Nylon/Fiberglass blade 23x43 cm
- Light and professional

Item	Part number	Dimension	Diameter
SUP PADDLE FIBERGLASS	6531500N	170/215 cm	Ø 29 x 1.8 mm
SUP PADDLE ALU	6531600N	170/215 cm	Ø 29 x 1.4 mm

# PAGAIE SUP

SUP PADDLES

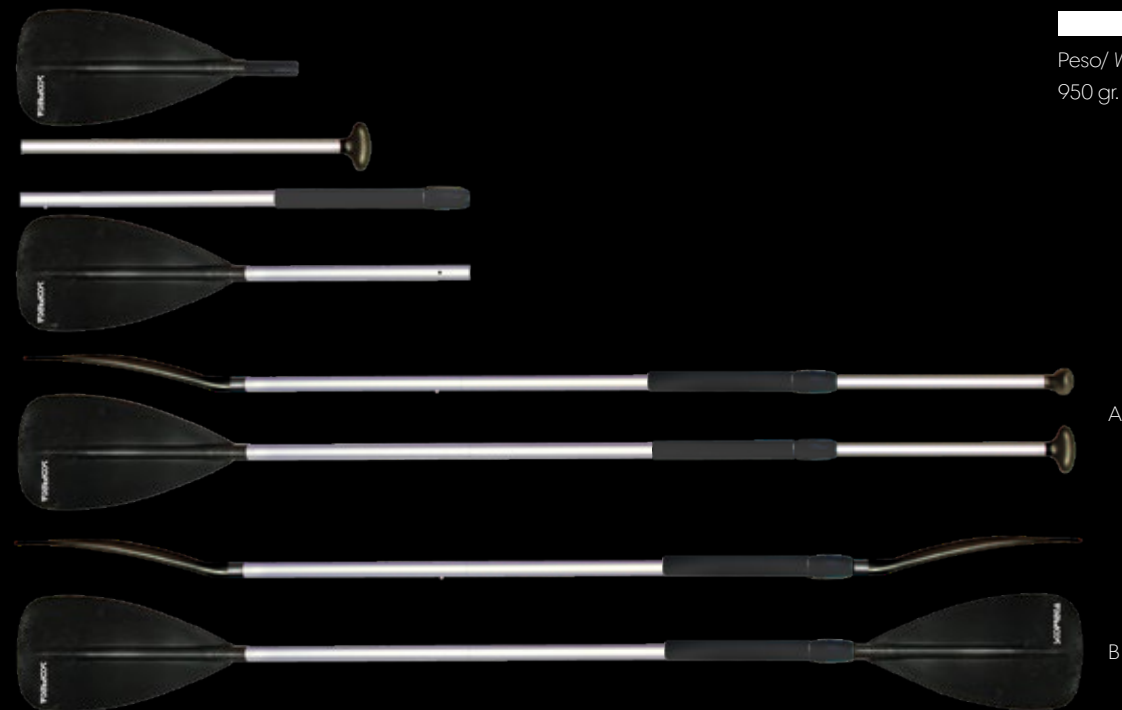

## DOUBLE SUP PADDLE KIT

Peso/ Weight  
950 gr. - FIBERGLASS

Pagaia telescopica con regolazione rapida

- Disponibile nella versione ALLUMINIO o FIBRA DI VETRO
- Trasformabile in pagaia a pala doppia, per utilizzo da seduti
- Regolabile da 170 a 215 cm nella modalità SINGOLA PALA (A); lunghezza fissa 205 cm nella modalità PALA DOPPIA (B)
- Grazie al meccanismo di regolazione rapida, la seconda pala è orientabile a 360°
- Smontabile in 4 sezioni (ingombro max 86 cm)
- Pala in nylon caricato vetro 23x43 cm
- Leggera e professionale

Quick-adjustment telescopic paddle

- Available in ALU or FIBERGLASS versions
- Transformable in a double-blade paddle, to be used while seated
- Adjustable from 170 to 215 cm in the SINGLE-BLADE mode (A); fixed length 205 cm in the DOUBLE-BLADE mode (B)
- Thanks to the quick-adjustment lock, the second blade is 360° revolving
- Collapsible in 4 parts (max dimension 86 cm)
- Nylon/Fiberglass blade 23x43 cm
- Light and professional

Item	Part number	Dimension	Diameter
DOUBLE SUP PADDLE KIT FIBERGLASS	6531700N	A 170/215 cm B 205 cm	Ø 29 x 1.8 mm

## ON DEMAND, ONLY

Item	Part number	Dimension	Diameter	MOQ	Peso/ Weight
DOUBLE SUP PADDLE KIT ALU	6531800N	A 170/215 cm B 205 cm	Ø 29 x 1.4 mm	200pcs	1050 gr. - ALU



03

**ACCESSORI**  
ACCESSORIES

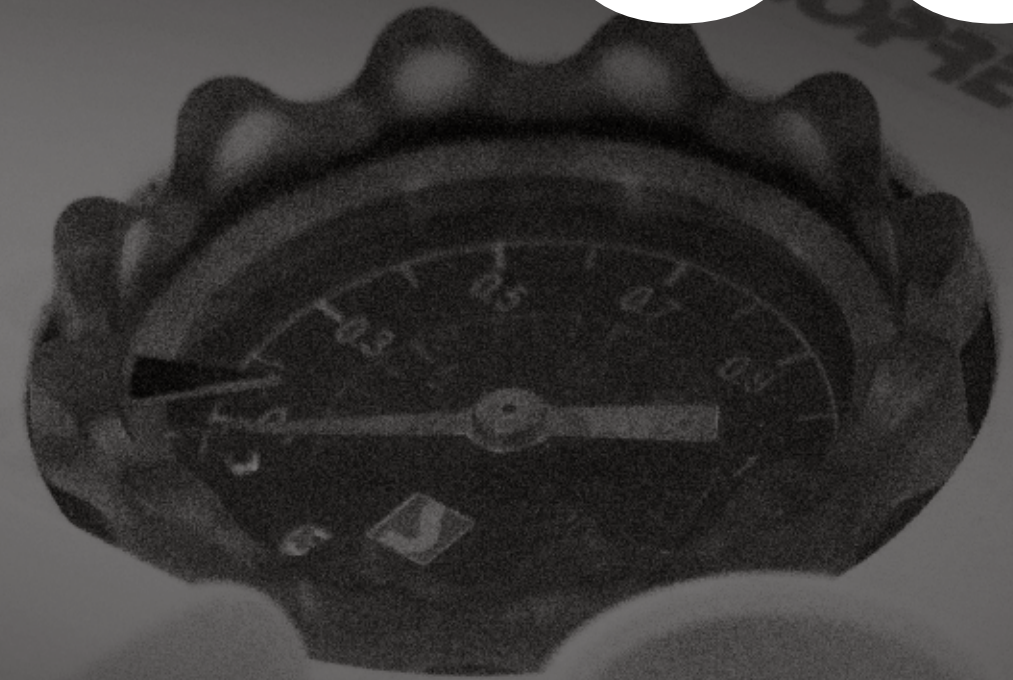



# MANOMETRI

PRESSURE GAUGES

Manometro digitale

- Pressione di esercizio: 0-999 mbar (0-14.5 psi)
- Risoluzione: 10 mbar (0.15 psi)
- Precisione: < 1,0%
- Unità programmabili: mbar - psi - Kpa - bar
- Limite di pressione: >150%
- Grado protezione involucri: IP65
- Alimentazione: batteria 9V-DC
- Batterie non incluse

Digital manometer

- Pressure: 0-999 mbar (0-14.5 psi)
- Resolution: 10 mbar (0.15 psi)
- Precision: < 1.0%
- Programmable units: mbar - psi - Kpa - bar
- Breaking pressure: >150%
- Degree of Protection: IP65
- Power supply: battery 9V-DC
- Batteries not included



Confezione singola in borsa  
Single packing in bag

DIGITAL PRESSURE GAUGE

Item	Part number	Pcs
SP 150	R551088N	1



ANALOG PRESSURE GAUGE		
Item	Part number	Press.
SP 98/1	R201098	1 bar (14.5 psi)
SP 98/0.5	R201099	0.5 bar (7.3 psi)

- 1 bar (14.5 psi) - per / for BRAVO 6M
- 0.5 bar (7.3 psi) - per / for BRAVO 7M, BRAVO 8M

ANALOG PRESSURE GAUGE		
Item	Part number	Press.
SP 236	R201110	0 - 2 bar
SP 237	R201111	0 - 1 bar

- 2 bar (29.0 psi) - per / for BRAVO 100 / 101 / 4XS
- 1 bar (14.5 psi) - per / for BRAVO 110 / 4WD

ANALOG PRESSURE GAUGE		
Item	Part number	Press.
SP 90 SUP	R551097N	0.5/1.5 bar (7.3/21.8 psi)
SP 90-2 SUP	R551002N	0/2 bar (0/29 psi)

- per / for BRAVO SUP, BRAVO SUP HP
- avvitabile/screwable

OARS AND PADDLES

S

B



A



B

ANALOG PRESSURE GAUGE		
Item	Part number	Press.
SP 90 B (bayonet)	R551093N	1 bar (14.5 psi)
SP 90 S (screwable)	R551098N	1 bar (14.5 psi)

- Type B - per / for BRAVO 4 ALU RED, BRAVO 4 ALU RED KITE
- Type S - per / for BRAVO 4, BRAVO 4 SH

- S - avvitabile/screwable
- B - baionetta/bayonet

ANALOG PRESSURE GAUGE		
Item	Part number	Press.
SP 125/1	R551091N	1.0 bar (14.5 psi)
SP 125/0.5	R551094N	0.5 bar (7.3 psi)

Permette il controllo della pressione con una lettura progressiva durante il gonfiaggio. The special configuration allows a progressive measurement of the pressure.

**A** Controllo della pressione durante il gonfiaggio / Pressure control while inflating

**B** Controllo della pressione / "Anytime" pressure control



ANALOG PRESSURE GAUGE			
Item	Part number	Gauge meter	Suitable for valve
SP 119/HR/0.5	R151093N	0.5 bar (7.3 psi)	HR
SP 119/HR/1.0	R151094N	1.0 bar (14.5 psi)	HR
SP 119/2005/0.5	R151096N	0.5 bar (7.3 psi)	Bravo 2005 / H3
SP 119/2005/1.0	R151095N	1.0 bar (14.5 psi)	Bravo 2005 / H3
SP 119/ADJ/0.5	R151092N	0.5 bar (7.3 psi)	adattabile/adjustable
SP 119/ADJ/1.0	R151090N	1.0 bar (14.5 psi)	adattabile/adjustable
SP 119/ADJ/2.0	R151101N	2.0 bar (29.0 psi)	adattabile/adjustable
SP 119/2005-HR-HR/2.0	R151102N	2.0 bar (29.0 psi)	Bravo 2005 / HR / H3

# VALVOLE DI GONFIAGGIO

## INFLATION VALVES

- Valvola versatile, utilizzabile sia per bassa che alta pressione.
- Massima tenuta grazie alla speciale guarnizione a labbro di silicone (massima pressione 2 bar).
- Robusta e compatta con un tappo ergonomico.
- Apertura PUSH-PUSH (mod. BRAVO 2005) e PUSH-TURN (mod. BRAVO 2000/BRAVO 2001/BRAVO 2014).
- Disponibile anche con rete protettiva (A102870N / A102872N / A102718N).

- Adaptable valve, suitable both for low and high pressure.
- Very high sealing capacity with special silicon gasket (max pressure 2 bar).
- Very compact with an ergonomic cap.
- PUSH-PUSH principle opening (mod. BRAVO 2005) and PUSH-TURN (mod. BRAVO 2000/BRAVO 2001/BRAVO 2014).
- Available with protective mesh (A102870N / A102872N / A102718N).



BRAVO 2005



BRAVO 2005/A



BRAVO 2005 SUP + MESH

### INSTALLATION

#### BRAVO 2005

Item	Part number	Color
BRAVO 2005	A102800N	nero/black
	A102801N	grigio/grey
	A102802N	grigio scuro/dark grey
BRAVO 2005/A	A102815N	nero/black
	A102816N	grigio/grey
	A102806N	grigio scuro/dark grey
BRAVO 2005 SUP + MESH	A102870N	grigio/grey

BRAVO 2000		
Item	Part number	Color
BRAVO 2000	A102705N	nero/black
	A102706N	grigio/grey

### INSTALLATION

BRAVO 2001		
Item	Part number	Color
BRAVO 2001	A102701N	nero/black
	A102700N	grigio/grey

### INSTALLATION

BRAVO 2014 - BRAVO 2014 + MESH		
Item	Part number	Color
BRAVO 2014	A102716N	nero/black
	A102717N	grigio/grey
BRAVO 2014 + MESH	A102718N	grigio/grey

### INSTALLATION

#### ART. 721

- ART. 721 / A942010N
- Chiave per valvole / Key for valves
- Bravo 2000 - Bravo 2001 - Bravo 2005 - BRAVO 2014 - VA 100





# VALVOLE DI GONFIAGGIO

## INFLATION VALVES

- Valvola di gonfiaggio ad ampio flusso, specificatamente sviluppata per grandi strutture gonfiabili.
- Massima tenuta grazie alla speciale guarnizione a labbro in silicone
- Robusta e compatta
- Apertura "push-turn"

Se abbinata ad un gonfiatore con tubo da  $\varnothing$  40 mm, permette un'elevatissima velocità di gonfiaggio e sgonfiaggio.

- *High-Volume inflation valve specifically developed for big inflatable structures*
- *Very high sealing capacity thanks to a special silicon gasket*
- *Very compact and resistant*
- *"Push-turn" principle opening*

*In combination with a  $\varnothing$  40 mm hose-inflator, it allows very fast inflation and deflation.*



BRAVO 260 H.V.			
Item	Part number	Material	Color
BRAVO 260 H.V.	A131000N	POM	nero/black

### INSTALLATION

SP Z183	
- R801374	SP Z183
Chiavi per valvola BRAVO 260 H.V.	

- R801374 SP Z183  
Keys for valve BRAVO 260 H.V.

ART. 677

Tappo in ABS/ABS cap

VA5/2

Boston valve

Codolo/Base  
ART. 687

ART VA5/2 - 677 - 687

Item	Part number	Material	Color
VA5/2	6892009N	Nylon	nero/black
677	A401677	ABS	nero/black
687	KA401687	PVC	nero/black
	KA402688	PU	nero/black

### INSTALLATION

ART. 230

Valvola di solo gonfiaggio.  
Inflation-only valve.

ART 230			
Item	Part number	Material	Color
230	A101230	Nylon	nero/black

### 230 INSTALLATION



# VALVOLE DI GONFIAGGIO

INFLATION VALVES

- Mini BOSTON valvola
- Nuovo design per gonfiare/sgonfiare rapidamente
- Robusta e compatta
- Resistente ai raggi UV, facile assemblaggio
- Ideale per KITE e tutte le applicazioni su PVC

- Mini BOSTON-style valve
- New design for fast inflation/deflation
- Compact size (external encumbrance <3 cm)
- UV resistant PVC base, easy to glue or HF weld
- Suitable to KITES and all PVC base applications



## INSTALLATION

MINI BOSTON VALVE			
Item	Part number	Material	Color
MINI BOSTON VALVE	A131100N	PVC	nero/black

# VALVOLE DI SOVRAPRESSIONE

RELIEF VALVES

Valvola di sovrappressione specificatamente sviluppata per applicazioni ad alta pressione. Estremamente compatta e resistente, è particolarmente adatta all'installazione in tavole SUP e tubolari ad alta pressione.

*Pressure Relief Valve specifically developed for high pressure applications. High resistance and limited size make it particularly suitable for SUP boards and high pressure tubes.*



Collaudata al 100% in adempimento alla norma ISO 15738.  
100% tested before shipping in accordance with ISO 15738.

## INSTALLATION

Item	Part number	Calibration	Color	RV SUP					
				Nominal		Opening		Closing	
				mbar	psi	mbar	psi	mbar	psi
RV SUP	KA080404	17/19	blu/blue	1241	18,0	1310	19,0	1172	17,0
	KA080405	18/20	arancio/orange	1310	19,0	1379	20,0	1241	18,0
	KA080406	21/23	nero/black	1517	22,0	1586	23,0	1448	21,0

# VALVOLE DI SOVRAPRESSIONE

RELIEF VALVES



Collaudata al 100% in adempimento alla norma ISO 15738.  
100% tested before shipping in accordance with ISO 15738.

## INSTALLATION

RV 70

Item	Part number	Calibration	Color	Opening			Closing		
				Pax 1000	mbar	psi	Pax 1000	mbar	psi
RV 70	KA080301	180/150	rosso/red	18.0	180	2.6	15.0	150	2.2
	KA080302	200/170	nero/black	20.0	200	2.9	17.0	170	2.5
	KA080303	230/200	grigio/grey	23.0	230	3.3	20.0	200	2.9
	KA080304	255/225	verde/green	25.5	255	3.7	22.5	225	3.3
	KA080305	280/250	blu/blue	28.0	280	4.0	25.0	250	3.6



Collaudata al 100% in adempimento alla norma ISO 15738.  
100% tested before shipping in accordance with ISO 15738.

\* Tolleranza di produzione -5 +10% - Tolleranza funzionale per l'utente -5 +20%  
Production test tolerances -5 +10% - Functional tolerances for user -5 +20%

## INSTALLATION

RVG 70

Item	Part number	Calibration	Color	Opening			Closing		
				Pax 1000	mbar	psi	Pax 1000	mbar	psi
RVG 70	KA080173	180/150	rosso/red	18.0	180	2.6	15.0	150	2.2
	KA080174	200/170	nero/black	20.0	200	2.9	17.0	170	2.5
	KA080175	230/200	grigio/grey	23.0	230	3.3	20.0	200	2.9
	KA080176	255/225	verde/green	25.5	255	3.7	22.5	225	3.3
	KA080177	280/250	blu/blue	28.0	280	4.0	25.0	250	3.6



# VALVOLE DI SOVRAPRESSIONE

RELIEF VALVES

Studiata per proteggere i gommoni da eccessiva pressione dovuta a sovra-gonfiaggio o ad innalzamenti causati da escursione termica. La valvola può essere lasciata nella posizione aperta "OPEN" oppure chiusa, con apertura periodica di controllo e conseguente sfiato. Il tappo è amovibile e l'apertura e chiusura si effettuano ruotando, con il palmo della mano premuto, fino a far combaciare il punto colorato con la tacca di riferimento. Per l'assemblaggio del tappo, da parte del fabbricante, è necessaria una chiavetta esagonale.

- Molto affidabile
- Molto precisa
- Collaudata al 100%
- Adatta all'impiego in adempimento alla norma ISO 15738
- Diametro del foro nel tessuto: 37 mm

*Studied for the protection of rubber dinghies from excessive pressure due to over-inflation or increases caused by thermal excursion. The valve can be left in the "OPEN" position or else left closed, with periodical control opening and consequent deflation. The stopper can not be removed and the opening and closing are made by rotating the stopper with the palm of the hand pressed to ensure that the coloured point meets with the reference point. For assembly of the stopper by the manufacturer, a hexagonal key is needed.*

- Very reliable
- Very precise
- 100% tested
- Suitable for use in accordance with standard ISO 15738
- Diameter of fabric hole: 37 mm



A valvola aperta lo scarico d'aria è limitato dalla presenza del tappo ma è largamente sufficiente per evitare che un efficiente gonfiatore elettrico per gommoni possa gonfiare i tubolari oltre la pressione raccomandata dai costruttori. La valvola opera in una forcella di pressione (apertura/chiusura) molto limitata, intorno al 10% del valore nominale.

*With the valve open, the air release is limited by the presence of the stopper but is still sufficient to prevent an efficient electrical inflator for dinghies from inflating the tubes over the pressure recommended by the manufacturers. The valve operates in a very limited (opening/closing) pressure range, about 10% of the nominal value.*

## INSTALLATION

VA 100										
Item	Part number	Calibration	Color	Opening			Closing			
				Pax 1000	mbar	psi	Pax 1000	mbar	psi	
VA 100	A080195N	270/230	verde/green	2.7	270	3.9	2.3	230	3.3	
	A080196N	300/270	giallo/yellow	3.0	300	4.3	2.7	270	3.9	
	A080197N	350/310	rosso/red	3.5	350	5.1	3.1	310	4.5	



Collaudata al 100% in adempimento alla norma ISO 15738

*100% tested before shipping in accordance with ISO 15738*

## INSTALLATION

VA 50											
Item	Part number			Calibration	Color	Opening			Closing		
	PVC base	NBR base	PU base			Pax 1000	mbar	psi	Pax 1000	mbar	psi
VA 50	A080120	A080122	A080121	60/25	bianco/white	6.0	60	0.87	2.5	25	0.36
	A080130	A080132	A080131	80/50	rosa/pink	8.0	80	1.16	5.0	50	0.72
	A080163	A080164	A080165	180/140	azzurro/cyan	18.0	180	2.60	14.0	140	2.03
	A080140	A080142	A080141	200/150	oro/gold	20.0	200	2.90	15.0	150	2.17
	A080150	A080152	A080151	225/170	blu/blue	22.5	225	3.26	17.0	170	2.46
	A080160	A080162	A080161	250/200	arancia/orange	25.0	250	3.62	20.0	200	2.90
A080166	A080153	A080168	330/250	nero/black	33.0	330	4.79	25.0	250	3.36	



Collaudata al 100% in adempimento alla norma ISO 15738

*100% tested before shipping in accordance with ISO 15738*

## INSTALLATION

VA 285										
Item	Part number	Calibration	Color	Opening			Closing			
				Pax 1000	mbar	psi	Pax 1000	mbar	psi	
VA 285	A080020	60/25	bianco/white	6.0	60	0.87	2.5	25	0.36	
	A080021	80/50	rosa/pink	8.0	80	1.16	5.0	50	0.72	
	A080025	180/140	azzurro/cyan	18.0	180	2.60	14.0	140	2.03	
	A080022	200/150	oro/gold	20.0	200	1.44	15.0	150	2.17	
	A080023	225/170	blu/blue	22.5	225	2.60	17.0	170	2.46	
	A080024	250/200	arancia/orange	25.0	250	2.90	20.0	200	2.90	
A080026	330/250	nero/black	33.0	330	4.79	25.0	250	3.63		



Collaudata al 100% in adempimento alla norma ISO 15738.  
100% tested before shipping in accordance with ISO 15738.

Item	Part number			Calibration	Color	Opening			Closing		
	PVC base	NBR base	PU base			Pax 1000	mbar	psi	Pax 1000	mbar	psi
	VA 30										
VA 30	A080050	A080052	A080051	60/25	bianco/white	6.0	60	0.87	2.5	25	0.36
	A080060	A080062	A080061	80/50	rosa/pink	8.0	80	1.16	5.0	50	0.72
	A080070	A080072	A080071	100/65	verde/green	10.0	100	1.44	6.5	65	0.94
	A080080	A080082	A080081	180/135	giallo/yellow	28.0	280	2.60	13.5	135	1.96
	A080090	A080092	A080091	200/150	oro/gold	20.0	200	2.90	15.0	150	2.17
	A080100	A080102	A080101	225/170	blu/blue	22.5	225	3.26	17.0	170	2.46
	A080110	A080112	A080111	240/185	rosso/red	24.0	240	3.48	18.5	185	2.68
	A080047	A080048	A080049	260/200	arancio/orange	26.0	260	3.76	20.0	200	2.90

**INSTALLATION**



Collaudata al 100% in adempimento alla norma ISO 15738.  
100% tested before shipping in accordance with ISO 15738.

**INSTALLATION**

Item	Part number	Calibration	Color	Opening			Closing		
				Pax 1000	mbar	psi	Pax 1000	mbar	psi
				VA 280					
VA 280	A080001	60/25	bianco/white	6.0	60	0.87	2.5	25	0.36
	A080002	80/50	rosa/pink	8.0	80	1.16	5.0	50	0.72
	A080003	100/65	verde/green	10.0	100	1.44	6.5	65	0.94
	A080004	180/135	giallo/yellow	18.0	180	2.60	13.5	135	1.96
	A080005	200/150	oro/gold	20.0	200	2.90	15.0	150	2.17
	A080006	225/170	blu/blue	22.5	225	3.26	17.0	170	2.46
	A080007	240/185	rosso/red	24.0	240	3.48	18.5	185	2.68
	A080008	260/200	arancio/orange	26.0	260	3.76	20.0	200	2.90

Item	Part number	Calibration	Color	Opening			Closing		
				Pax 1000	mbar	psi	Pax 1000	mbar	psi
				VA 240					
VA 240	A101242	60/25	bianco/white	6.0	60	0.87	2.5	25	0.36
	A101239	80/50	rosa/pink	8.0	80	1.16	5.0	50	0.72
	A101243	100/65	verde/green	10.0	100	1.44	6.5	65	0.94
	A101241	180/135	giallo/yellow	18.0	180	2.60	13.5	135	1.96
	A101249	200/150	oro/gold	20.0	200	2.90	15.0	150	2.17
	A101246	225/170	blu/blue	22.5	225	3.26	17.0	170	2.46
	A101240	240/185	rosso/red	24.0	240	3.48	18.5	185	2.68
	A121238	260/200	arancio/orange	26.0	260	3.76	20.0	200	2.90

Collaudata al 100% in adempimento alla norma ISO 15738.  
100% tested before shipping in accordance with ISO 15738.

**INSTALLATION**



Item	Part number	Calibration	Color	Opening			Closing		
				Pax 1000	mbar	psi	Pax 1000	mbar	psi
				VA 20					
VA 20	A101027	60/25	bianco/white	6.0	60	0.87	2.5	25	0.36
	A101023	80/50	rosa/pink	8.0	80	1.16	5.0	50	0.72
	A101021	100/65	verde/green	10.0	100	1.44	6.5	65	0.94
	A101020	180/135	giallo/yellow	18.0	180	2.60	13.5	135	1.96
	A101025	200/150	oro/gold	20.0	200	2.90	15.0	150	2.17
	A101022	225/170	blu/blue	22.5	225	3.26	17.0	170	2.46
	A101024	240/185	rosso/red	24.0	240	3.48	18.5	185	2.68
	A101028	260/200	arancio/orange	26.0	260	3.76	20.0	200	2.90

Collaudata al 100% in adempimento alla norma ISO 15738.  
100% tested before shipping in accordance with ISO 15738.

**INSTALLATION**



Item	Part number	Calibration	Color	Opening			Closing		
				Pax 1000	mbar	psi	Pax 1000	mbar	psi
				VA 21					
VA 21	A101170N	60/25	bianco/white	6.0	60	0.87	2.5	25	0.36
	A101160N	80/50	rosa/pink	8.0	80	1.16	5.0	50	0.72
	A101150N	100/65	verde/green	10.0	100	1.44	6.5	65	0.94
	A101140N	180/135	giallo/yellow	18.0	180	2.60	13.5	135	1.96
	A101130N	200/150	oro/gold	20.0	200	2.90	15.0	150	2.17
	A101120N	225/170	blu/blue	22.5	225	3.26	17.0	170	2.46
	A101110N	240/185	rosso/red	24.0	240	3.48	18.5	185	2.68
	A101100N	260/200	arancio/orange	26.0	260	3.76	20.0	200	2.90
A101180N	350/300	nero/black	35.0	350	5.07	30.0	300	4.35	

Collaudata al 100% in adempimento alla norma ISO 15738.  
100% tested before shipping in accordance with ISO 15738.

**INSTALLATION**



# KIT AGGANCIAMENTO RAPIDO

FAST HOOK KIT

Aggancio realizzato in nylon caricato, robusto, di rapido montaggio e smontaggio, riduce notevolmente la manodopera necessaria per connettere i tubolari all'archetto della zattera. È possibile ordinare la versione con valvola di sovrappressione, con valvola unidirezionale, oppure bidirezionale. I codici si riferiscono al KIT completo. I pezzi sono forniti nei 3 componenti principali smontati.

Fastener made in reinforced nylon that allows rapid mounting and dismounting, thus notably reducing the manpower which is necessary to assemble the tubulars onto the liferaft bow. Three versions are available, with overpressure relief valve, one way or two ways. Part numbers refer to the complete kit. Parts are provided disassembled into their 3 basic components.

codolo con inserto  
base with nylon insert

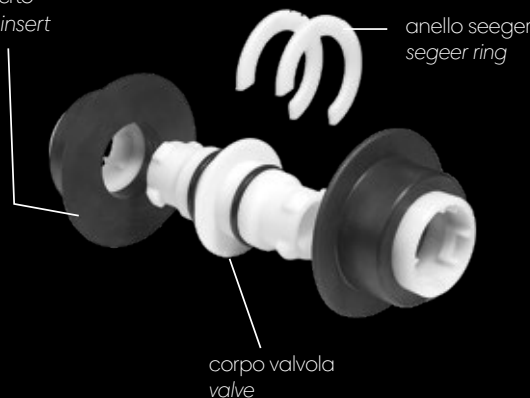

anello seeger  
seeger ring

corpo valvola  
valve



Collaudata al 100% in adempimento alla norma ISO 15738.  
100% tested before shipping in accordance with ISO 15738.

## ON DEMAND

ART 295

Con valvola di sovrappressione  
With over pressure valve

ART 296

Con valvola unidirezionale  
With oneway valve

ART 297

Con valvola bidirezionale  
With two-way valve

### INSTALLATION

ART 295 - 296 - 297

Item	Part number			Calibration	Color	Opening			Closing		
	PVC base	NBR base	PU base			Pax 1000	mbar	psi	Pax 1000	mbar	psi
ART. 295	A080200	A080204	A080208	60/25	bianco/white	6.0	60	0.87	2.5	25	0.36
	A080202	A080206	A080210	80/50	rosa/pink	8.0	80	1.16	5.0	50	0.72
ART. 296	A080220	A080222	A080224	Con valvola unidirezionale / With oneway valve							
ART. 297	A080230	A080232	A080234	Con valvola bidirezionale / With two-way valve							

Adatta all'impiego in adempimento alla norma ISO 15738. / Suitable to be used to meet the ISO 15738 norm.

# RACCORDI

FITTINGS

Valves	Art. 711 Part number A600010	Art. 712 Part number A600020	Art. 718 Part number A600030	Art. 718/ADJ Part number A600040	Art. 718/2005 Part number A600050	Art. 718/HR Part number A600060	Art. 734 Part number A600070	Art. 718/HRK Part number A600080
2000	•	•					•	
2001	•	•	•	•				
2005-2005/A	•	•		•	•			
2014	•	•		•			•	
HR	•	•	•	•		•		
H3	•	•			•			•
ALTRE/OTHERS	•	•		•				

### RACCORDI VALIDI PER I SEGUENTI GONFIATORI FITTINGS SUITABLE FOR THE FOLLOWING PUMPS

tutti tranne gonfiatori con manometro e gonfiatori elettrici	solo per gonfiatori con manometro e gonfiatori elettrici	tutti i gonfiatori a mano e a pedale	tutti	tutti	tutti	tutti	tutti tranne gonfiatori con manometro e gonfiatori elettrici	tutti
all except pumps with pressure gauge and electric pumps	only for pumps with pressure gauge and electric pumps	all hand and foot pumps	all	all	all	all	all except pumps with pressure gauge and electric pumps	all

### ADJUSTABLE



Per adattare alle varie valvole procedere come il disegno:

- 1) Inserire la guarnizione nera, che deve sempre aderire alla valvola
- 2) Inserire il distanziale a seconda della necessità
- 3) Regolare l'altezza della vite per far aprire la valvola

To adapt to the various valves proceed as in the drawing:

- 1) Insert the black gasket, which must always adhere to the valve
- 2) Insert the spacers as needed
- 3) Adjust the height of the screw to open the valve



# MANIGLIE

HANDLES

ART 333				
Item	Part number	Material	Color	Dim. mm
333	A158416N	PVC	nero/black	90x280xh65
	A158406N	PVC	grigio/grey	90x280xh65
	A939333N	MPR	nero/black	90x280xh65
	A939406N	MPR	grigio/grey	90x280xh65



ART 331				
Item	Part number	Material	Color	Dim. mm
331	A158410N	PVC	nero/black	90x245xh47
	A158412N	PVC	grigio/grey	90x245xh47
	A939405N	MPR	grigio/grey	90x245xh47



ART 322				
Item	Part number	Material	Color	Dim. mm
322	A151322N	PVC	nero/black	90x220xh32
	A151323N	PVC	grigio/grey	90x220xh32
	A901323N	MPR	grigio/grey	90x220xh32



# MANIGLIE

HANDLES

ART 313				
Item	Part number	Material	Color	Dim. mm
313	A151313N	PVC	nero/black	100x210xh38
	A151314N	PVC	grigio/grey	100x210xh38



ART 306 / 307				
Item	Part number	Material	Color	Dim. mm
306	A151306N	PVC	nero/black	260x110x45 mm
	A158306N	PVC	grigio/grey	260x110x45 mm
	A901306N	MPR	nero/black	260x110x45 mm
	A939306N	MPR	grigio/grey	260x110x45 mm
307	A151307N	PVC	nero/black	260x110x45 mm
	A158307N	PVC	grigio/grey	260x110x45 mm
	A901307N	MPR	nero/black	260x110x45 mm
	A939307N	MPR	grigio/grey	260x110x45 mm



**Da ordinare in coppia**  
**To be ordered per pair**

ART 321				
Item	Part number	Material	Color	Dim. mm
321	A151321N	PVC	nero/black	70x205xh46
	A151324N	PVC	grigio/grey	70x205xh46



# FISSAREMI

OAR HOLDERS

ART 681

Item	Part number	Material	Color	Dim. mm	Hole mm.
681	A309686N	PVC	nero/black	80x132xh44	Ø 32 - 35
	A309688N	PVC	grigio/grey	80x132xh44	Ø 32 - 35



ART 669

Item	Part number	Material	Color	Dim. mm	Hole mm.
669	A301669N	PVC	nero/black	64x91xh41	Ø 30
	A309669N	PVC	grigio/grey	64x91xh41	Ø 30



ART 678

Item	Part number	Material	Color	Dim. mm	Hole mm.
678	A301678N	PVC	nero/black	75xh118	Ø 35
	A309681N	PVC	grigio/grey	75xh118	Ø 35
	A939678N	MPR	grigio/grey	75xh118	Ø 35



ART 675

Item	Part number	Material	Color	Dim. mm	Hole mm.
675	A309676	PVC	grigio/grey	63x90xh22	Ø 10

Fissaremi su pala  
Oar holder on blade



# PORTASCALMI

ROWLOCKS

ART 140 F + BH

Item	Part number	Material	Color	Dim. mm
140 F	A051400N	PVC	nero/black	90x200xh50
	A051401N	PVC	grigio/grey	90x200xh50
BH	S241146N	nylon/ottone nylon/brass	grigio/grey	Ø 35



ART 141-90 + B1 H1

Item	Part number	Material	Color	Dim. mm
141-90	A051410N	PVC	nero/black	90x200xh40
	A051420N	PVC	grigio/grey	90x200xh40
B1 H1	S241149N	nylon/ottone nylon/brass	nero/black	Ø 35
	S241147N	nylon/ottone nylon/brass	grigio/grey	Ø 35



ART 142-180

Item	Part number	Material	Color	Dim. mm
142-180	A901321N	MPR	grigio/grey	90x200xh40



ART 145-90					
Item	Part number	Material	Color	Dim. mm	Hole mm.
145-90	A051451N	PVC	grigio/grey	90x200xh40	Ø 10



Per questi scalmi usare remi con rosone / For these rowlocks, use oars with trim  
foro Ø 10 mm / hole Ø 10 mm

ART 146-180					
Item	Part number	Material	Color	Dim. mm	Hole mm.
146-180	A051460N	PVC	nero/black	90x200xh40	Ø 10
	A051461N	PVC	grigio/grey	90x200xh40	Ø 10
	A901341N	MPR	grigio/grey	90x200xh40	Ø 10



Per questi scalmi usare remi con rosone / For these rowlocks, use oars with trim  
foro Ø 10 mm / hole Ø 10 mm



Tutti i tipi sono smontabili senza scollare la base.  
All types can be disassembled without ungluing the base.



Cima passante in tutti i tipi  
Through rope in all types

ART 122				
Item	Part number	Material	Color	Dim. mm
122	A051123N	PVC	grigio/grey	130x91 xh 32

Abbinabile agli scalmi C-H e B-H / To be combined with C-H and B-H oarlocks

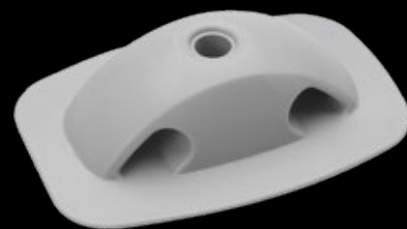

# PORTASCALMI

ROWLOCKS

ART 120 F				
Item	Part number	Material	Color	Dim. mm
120 F	A059133N	PVC	grigio/grey	110x170xh40

Abbinabile agli scalmi C-H e B-H / To be combined with C-H and B-H oarlocks



Scalmi regolabili / Possibili combinazioni supporto-perni / Nero o Grigio  
Adjustable oarlocks / Possible combination support-pin / Black or Grey

ART BF - BH - BL - CH		
Item	Part number	Color
BF	S241144N	nero/black
	S241178N	grigio/grey
BH	S241176N	grigio/grey
BL	S241173N	grigio/grey
CH	S241151N	grigio/grey
B1 H1	S241149N	nero/black
	S241147N	grigio/grey

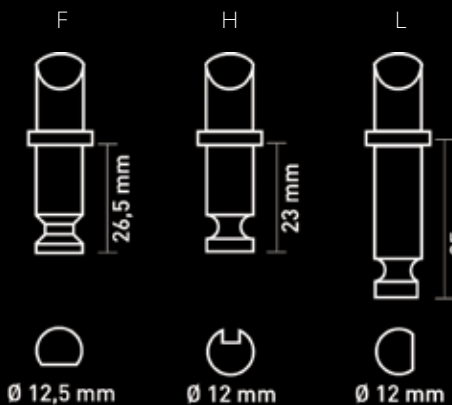

Ottone / Brass



Plastica / Plastic  
B Ø 35 mm  
C Ø 32 mm

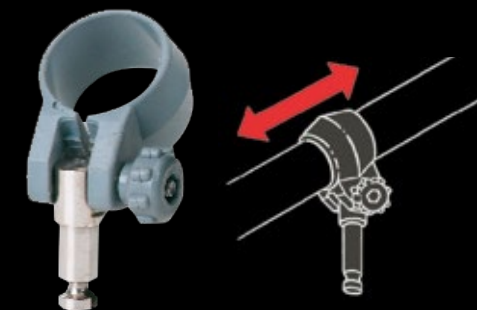

ART 117 - 620				
Item	Part number	Material	Color	Dim. mm
117	A051117N	PVC	nero/black	150x220xh30
	A059117N	PVC	grigio/grey	150x220xh30
	A901117N	MPR	nero/black	150x220xh30
620	A351620N	nylon	nero/black	80xh60 - Ø 35



ART 117



ART 620



# STROZZACIME E REGGICORDA

CLEAT AND ROPE HOLDERS

ART 535					
Item	Part number	Material	Color	Dim. mm	
535	A401535N	PVC	nero/black	250x200xh60	
	A401536N	PVC	grigio/grey	250x200xh60	
	A901535N	MPR	nero/black	250x200xh60	
	A901536N	MPR	grigio/grey	250x200xh60	

Strozzacima adatto per cime Ø 15/16 mm max/ Cleat suitable for rope Ø 15/16 mm max



ART 444					
Item	Part number	Material	Color	Dim. mm	
444	A201444N	PVC	nero/black	70x100xh33	
	A201445N	PVC	grigio/grey	70x100xh33	
	A201446N	MPR	nero/black	70x100xh33	
	A201447N	MPR	grigio/grey	70x100xh33	



ART 442					
Item	Part number	Material	Color	Dim. mm	
442	A201442N	PVC	nero/black	88x58xh26	
	A201443N	PVC	grigio/grey	88x58xh26	
				Ø 14	



ART 400					
Item	Part number	Material	Color	Dim. mm	
400	A205401N	PVC	nero/black	58x83xh24	
	A205402N	PVC	grigio/grey	58x83xh24	
	A901400N	MPR	nero/black	58x83xh24	



ART 401					
Item	Part number	Material	Color	Dim. mm	
401	A201401N	PVC	nero/black	Ø 75 - h 19	
	A291401N	PVC	grigio/grey	Ø 75 - h 19	
	A209401	PVC	grigio scuro/ dark grey	Ø 75 - h 19	
	A901401N	MPR	nero/black	Ø 75 - h 19	
	A939401N	MPR	grigio/grey	Ø 75 - h 19	



ART 409					
Item	Part number	Material	Color	Dim. mm	
409	A201409	PVC	nero/black	73x62xh25	

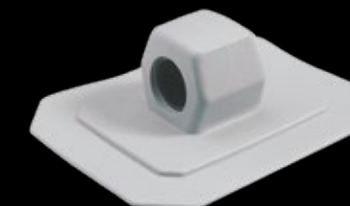

ART 110				
Item	Part number	Material	Color	Dim. mm
110	A051135N	PVC	nero/black	95x175xh22
	A051137N	PVC	grigio/grey	95x175xh22
	A939110N	MPR	grigio/grey	95x175xh22



Placca ovale ormeggio con anello in ottone nichelato.  
Mooring plate with nickel-plated brass ring.

# SUPPORTI ASSE

TRANSOM SUPPORTS

ART 672

Item	Part number	Material	Axis thickness	Color	Dim. mm
672	A401691N	PVC	18	grigio/grey	80x85xh32
	A401693N	PVC	22	nero/black	80x85xh32
	A401692N	PVC	22	grigio/grey	80x85xh32

ART 671

Item	Part number	Material	Axis thickness	Color	Dim. mm
671	A401672N	PVC	25,6	grigio/grey	540x100xh47

Per assi con spessore compreso tra 24 e 26 mm / For transom width between 24 and 26 mm

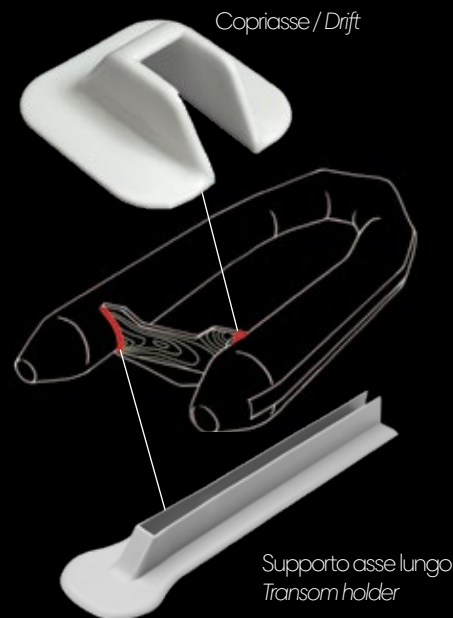

# PIASTRE PROTEGGI POPPA

PROTECTION PLATES

ART 695

Item	Part number	Color	Dimensions
695	B184000N	nero/black	223x84x5.5 mm
	B184001N	grigio/grey	223x84x5.5 mm



ART 696

Item	Part number	Color	Dimensions
696	B184010N	nero/black	308x104x5.5 mm
	B184011N	grigio/grey	308x104x5.5 mm



ART 697

Item	Part number	Color	Dimensions
697	B184020N	nero/black	300x209x7.5 mm
	B184021N	grigio/grey	300x209x7.5 mm



ART 698

Item	Part number	Color	Dimensions
698	B184030N	nero/black	430x324x6.6 mm
	B184031N	grigio/grey	430x324x6.6 mm



Costruite in polipropilene, aiutano nella protezione dello scafo. Possono essere applicate sia entro che fuori bordo. Disponibili in 4 misure, colori grigio o nero.

Made of polypropylene, they are useful in protecting the hull. They can be applied both in and outboard. Available in 4 sizes; colors: grey or black.

# CONI CODA

END CONES

ART 615

Item	Part number	Material	Color
615	A508001N	PVC	nero/black
	A401611N	PVC	grigio/grey
	A901613N	gomma/rubber	grigio/grey

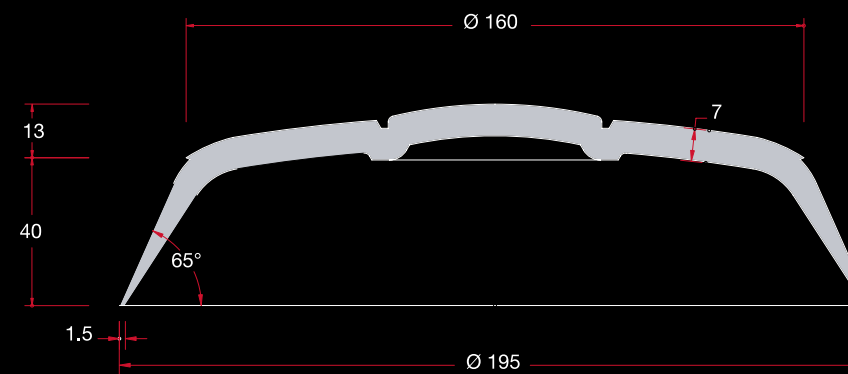

ART 610

Item	Part number	Material	Color
610	A901610	gomma/rubber	grigio/grey

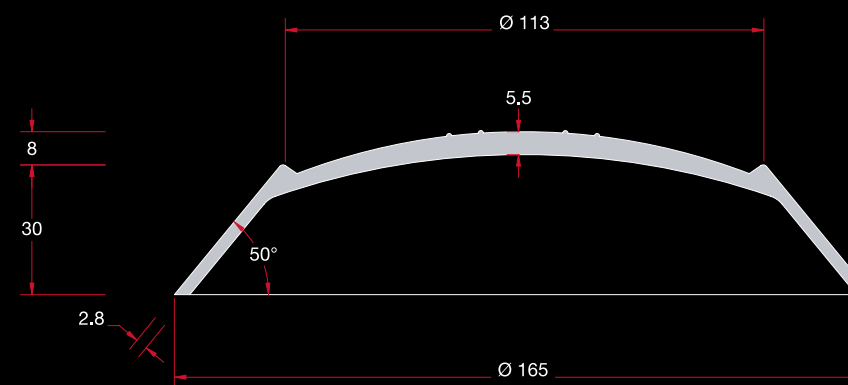

# SCARICHI ACQUA

WATER DRAINS

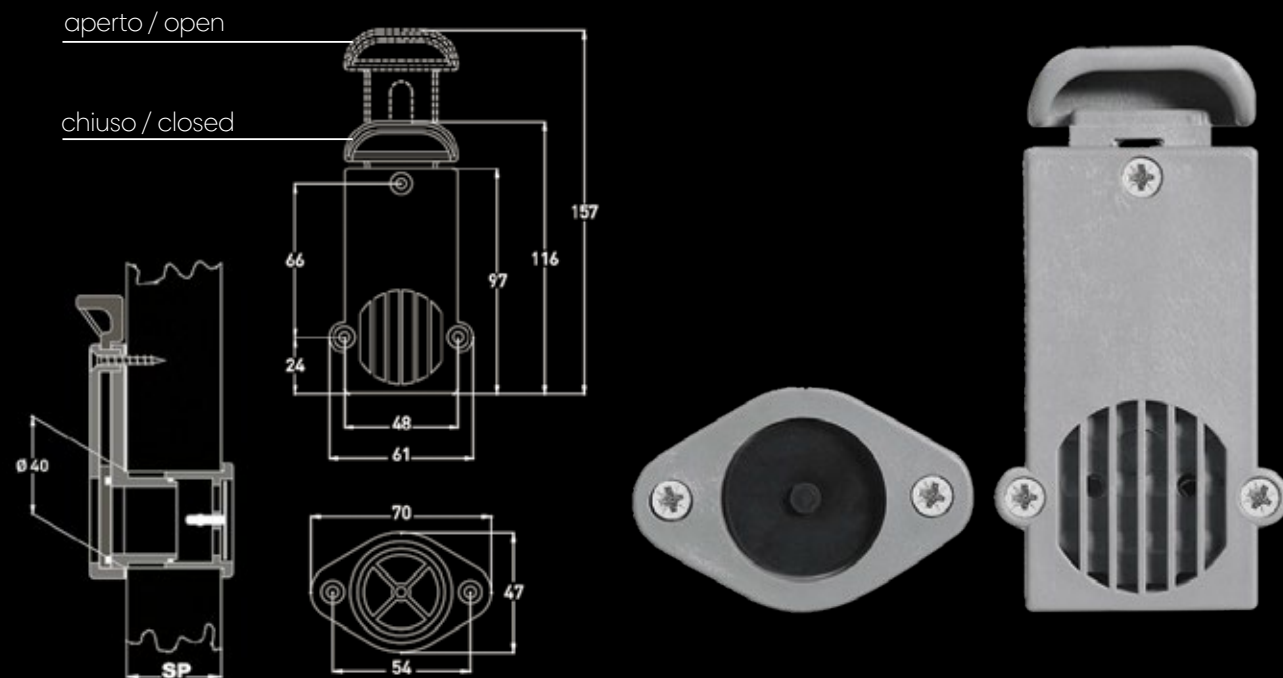

ART 614 - 612					
Item	Part number	Model	Axis thickness	Material	Color
612	A403612	19/26	19 ÷ 26 mm	nylon	grigio/grey
	A403613	25/39	25 ÷ 39 mm	nylon	grigio/grey
	A403625	38/63	38 ÷ 63 mm	nylon	grigio/grey

ART 311				
Item	Part number	Material	Color	Dim. mm
311	A401311N	nylon	nero/black	Ø 37
	A401312N	nylon	grigio/grey	Ø 37

Tappo di svuotamento  
Empty plug



# PARABORDI

FENDERS

I colori e le combinazioni di colore sono su richiesta del cliente per quantitativi minimi di 300 kg per i tipi leggeri e 500 kg per i tipi pesanti. Si prega di specificare il numero di RAL in fase di ordine. Possibilità di realizzare profili speciali su richiesta del cliente.

The colours combinations are on customer request to be specified on the order. The minimum order is 300 Kg for the light types and 500 Kg for the others. We can realize fenders with special profile on customer request.

ART 2100						
Item	Part number	Material	Color	Dim. mm	Weight g/m	Min Order
2100	K8702002	PVC	nero/black	70xh20	455	550m
	K8702009	PVC	grigio/grey	70xh20	455	550m

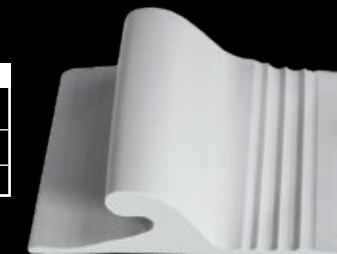

ART 2200						
Item	Part number	Material	Color	Dim. mm	Weight g/m	Min Order
2200	K8702001	PVC	nero/black	66xh4	179	1400m
	K8702008	PVC	grigio/grey	66xh4	179	1400m



ART 2400						
Item	Part number	Material	Color	Dim. mm	Weight g/m	Min Order
2400	K8702012	PVC	nero/black grigio/grey	73xh21	714	350m

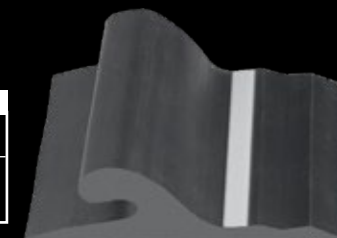

ART 2600						
Item	Part number	Material	Color	Dim. mm	Weight g/m	Min Order
2600	K8702065	PVC	nero/black	90xh25	1136	220m
	K8702060	PVC	grigio/grey	90xh25	1136	220m





ART 2250						
Item	Part number	Material	Color	Dim. mm	Weight g/m	Min Order
2250	K8702027	Rubber	nero/black	92xh24	720	280m
	K8702017	Rubber	grigio/grey	92xh24	900	250m

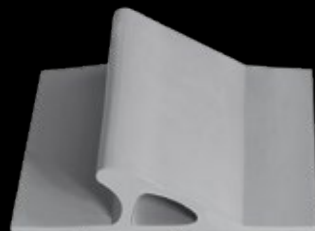

ART 2050						
Item	Part number	Material	Color	Dim. mm	Weight g/m	Min Order
2050	K8702003	PVC	nero/black	34xh16	294	850m
	K8702004	PVC	grigio/grey	34xh16	294	850m

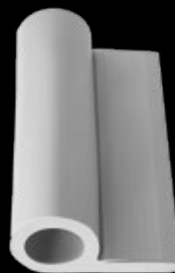

ART 2130						
Item	Part number	Material	Color	Dim. mm	Weight g/m	Min Order
2130	K8702035	Rubber	nero/black	90xh2	240	830m
	K8702015	Rubber	grigio/grey	90xh2	290	780m



ART 2150						
Item	Part number	Material	Color	Dim. mm	Weight g/m	Min Order
2150	K8702030	Rubber	grigio/grey	65xh13	520	550m



## PINNE SUP

### SUP FINS

CENTER FIN BASE BIG				
Item	Part number	Size	Color	Material
CENTER FIN BASE BIG	A401800N	mm 100x280	nero/black	ABS



CENTER FIN REMOVABLE BIG				
Item	Part number	Size	Color	Material
CENTER FIN REMOVABLE BIG	A401801N	depth mm 220	nero/black	PA6 + 30% FIBERGLASS



FIN BASE SMALL				
Item	Part number	Size	Color	Material
FIN BASE SMALL	A401802N	mm 75x200	nero/black	PVC / ABS



REMOVABLE FIN SMALL				
Item	Part number	Size	Color	Material
REMOVABLE FIN SMALL	A401803N	depth mm 140	nero/black	PA6 + 30% FIBERGLASS



SIDE FIN SMALL				
Item	Part number	Size	Color	Material
SIDE FIN SMALL	A401806N	base mm 53x215 depth mm 75	nero/black	PVC



SIDE FIN BIG				
Item	Part number	Size	Color	Material
SIDE FIN BIG	A401807N	base mm 55x195 depth mm 120	nero/black	PVC



# VARIE

MISCELLANEOUS PARTS

## Baywatch

La superficie particolarmente liscia e la speciale conformazione facilitano il traino del salvagente fino alla persona da soccorrere.

Il colore arancione consente un'ottima visibilità anche in condizioni atmosferiche avverse. La corda è saldamente fissata al corpo in modo da garantire la massima sicurezza.

## Baywatch Buoy

The smooth surface and the special shape allow the dragging of the item to the person to be helped.

The orange color guarantees a good visibility also in bad weather conditions. The rope is strongly fixed to the body in order to obtain the best safety.

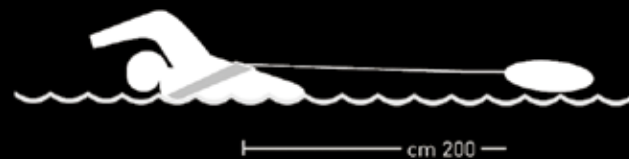

BAYWATCH			
Item	Part number	Weight	Dimensions
Baywatch	6400300	1,2 Kg	68 x 13 x 23 cm

# VARIE

MISCELLANEOUS PARTS

- Fornita completa di robusti distanziatori regolabili
- Tubo in alluminio anodizzato
- Plastica antiurto e antisdrucchiolo
- Bracci e distanziatori rientrabili
- Equipped with strong adjustable spacers
- Anodized aluminium tube
- Steps in plastic anti-shock and anti-sliding material
- Folding arms and folding spacers

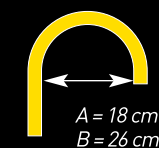

SF 2/A (2 steps)  
SF 3/B (3 steps)

Scalette per gommoni e piccole imbarcazioni / Ramps for rubber and small boats

SF	
Item	Part number
SF 2 (2 steps)	Type A 6351100
SF 3 (3 steps)	Type B 6351250

- Scaletta pieghevole di minimo ingombro
- Gradini in plastica antiurto e antisdrucchiolo

- Folder ladders
- Steps in plastic anti-shock and anti-sliding material



SGC 2 (2 steps)  
SGC 3 (3 steps)  
SGC 4 (4 steps)

SGC	
Item	Part number
SGC 2 (2 steps)	6361100
SGC 3 (3 steps)	6361200
SGC 4 (4 steps)	6361300

ART 528 - 529					
Item	Part number	Material	Color	Dim. mm	Part
528	8710528	Nylon	grigio/grey RAL 7001	300	Supporto bandiera Flag support
529	8710529	Gomma Rubber	grigio/grey RAL 7001	Ø 89	Base per supporto bandiera Base for flag support



ART 242				
Item	Part number	Material	Color	Weight gr.
242	A251242N	Expanded PVC	rosso/red	rosso/red

Anello lancia cima / Mooring ring

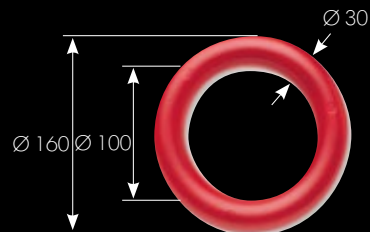
**ON DEMAND, ONLY**

ART 199					
Item	Part number	Material	Color	Dim. mm	Hole mm
199	A401500	nylon	bianco/white	35x33xh 15	Ø 4

Nottolino multiuso / Multipurpose latch

**VARIE**

MISCELLANEOUS PARTS

ART 404					
Item	Part number	Material	Color	Dim. mm	Hole mm.
404	A201404	PVC	nero/black	Ø 39 - h 16	Ø 10



ART 403					
Item	Part number	Material	Color	Dim. mm	Hole mm.
403	A201403	PVC	nero/black	Ø 60 - h 19	Ø 12
	A203403	PU	nero/black	Ø 60 - h 19	Ø 12

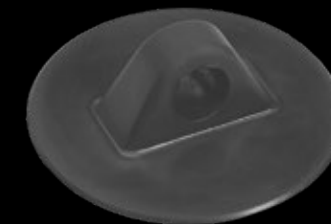

ART 300				
Item	Part number	Material	Color	Dim. mm
300	A151300	PVC	nero/black	200x90xh42





ART 210					
Item	Part number	Material	Color	Dim. mm	Hole mm.
210	A101210	PVC	nero/black	61 x h 15	Ø 29

Valvola piscina / Swimming pool valve



ART 634				
Item	Part number	Material	Color	Dim. mm
634	A401634	PVC	nero/black	104x68xh30

Codolo obliquo / Tilted flag base



ART 608				
Item	Part number	Material	Color	Dim. mm
608	A401608N	PVC	nero/black	80x80xh25

Codolo dritto / Straight base



ART 639				
Item	Part number	Material	Color	Dim. mm
639	A401639N	nylon	nero/black	265

Asta / Rod





04

**RICAMBI**

SPARE PARTS



# RACCORDI VALVOLE

VALVE FITTINGS

SP 47

Item	Part number	Description	Pcs
SP 47	R151047	Art. 711 - Raccordi valvola per gonfiatori a pedale e a mano Art. 711 - Valve fittings for foot pumps and hand pumps	1



SP 712

Item	Part number	Description	Pcs
SP 712	R151048	Art. 712 - Raccordi valvola per gonfiatori elettrici e gonfiatori con manometro Art. 712 - Valve fittings for electric pumps and pumps with pressure gauge	1



SP 118

Item	Part number	Description	Pcs
SP 118	R151062	Art. 718 - Raccordo a baionetta per valvole BRAVO 2001/ BRAVO 2004/HR Art. 718 - Bayonet fitting for valves BRAVO 2001/BRAVO 2004/HR	1



SP 138 - SP Z023

Item	Part number	Description	Pcs
SP 138	R151064	Art. 718/ADJ - Raccordo universale a baionetta Art. 718/ADJ - Universal bayonet fitting	1
SP Z023	R210031	Art. 718/ADJ - Raccordo universale a baionetta / Linkable version Art. 718/ADJ - Universal bayonet fitting / Linkable version	1



SP 139 - SP Z003 - SP Z022

Item	Part number	Description	Pcs
SP 139	R151065	Art. 718/2005 - Raccordo a baionetta per valvola BRAVO 2005 Art. 718/2005 - Bayonet fitting for valve BRAVO 2005	1
SP Z003	R151066	Art. 718/HRK - Raccordo a baionetta per valvole H3 Art. 718/HRK - Bayonet fitting for valves H3	1
SP Z022	R210030	Art. 718/2005-HR-HRK - Raccordo a baionetta per valvole BRAVO 2005/HR/HRK - Linkable version Art. 718/2005-HR-HRK - Bayonet fitting for valves BRAVO 2005/HR/HRK - Linkable version	1



SP 143

Item	Part number	Description	Pcs
SP 143	R151068	Art. 718/HR - Raccordo a baionetta per valvole BRAVO 2014/HR/SUPER VALVE Art. 718/HR - Bayonet fitting for valves BRAVO 2014/HR/SUPER VALVE	1



SP 120

Item	Part number	Description	Pcs
SP 120	R551120	Art. 734 - Raccordo per valvola BRAVO 2000 Art. 734 - Fitting for valve BRAVO 2000	1



SP 15 - SP 16

Item	Part number	Description	Pcs
SP 15	R151015	Raccordo triplo ø 20 mm Triple fitting ø 20 mm	1
SP 16	R151016	Raccordo triplo ø 25 mm Triple fitting ø 25 mm	1





SP Z027			
Item	Part number	Description	Pcs
SP Z027	R210035	Art. 760 - Raccordo per valvola 260 H.V. Art. 760 - Fitting for valve 260 H.V.	1

SP Z135			
Item	Part number	Description	Pcs
SP Z135	R151136	Riduttore ø 40-25 mm con uscita baionetta ø 40-25 mm reduction with bayonet end	1

NEW

## TUBI E RACCORDI

HOSES AND FITTINGS

Confezione singola da espositore  
Display single packing

TUBI E RACCORDI - HOSES AND FITTINGS			
Item	Part number	Description	Pcs
SP 212 S	R151017N	GM 4 / BRAVO 4 SH - attacco a vite / screw connection	1 kit
SP 212 SUP	R151022N	BRAVO SUP / SUP HP / SUP-3 (+ raccordi standard / + standard fittings)	1 kit
SP 212 S3-K	R151027N	BRAVO SUP / SUP HP / SUP-3 (+ raccordi kite / + kite fittings)	1 kit
SP 212 B	R151020N	GM 4 ALU R.E.D. - attacco a baionetta / bayonet connection	1 kit
SP 212 BK	R151021N	GM 4 ALU R.E.D. KITE - attacco a baionetta / bayonet connection	1 kit
SP 235	R151051	BRAVO 101 / BRAVO 110 / GM 4 XS / GM 4 WD / GM 110 MIL	1 kit
SP Z009	R210012	BRAVO 100 / BRAVO 100D	1 kit
SP 13	R151013	BRAVO 6 / BRAVO 6M / BRAVO 6 MIL / BRAVO 12	1 kit
SP 14	R151014	BRAVO 1 / BRAVO 2	1 kit
SP Z180	R151087	BRAVO 10 / GP10	1 kit
SP Z141	R151078	GP 5	1 kit
SP 25	R151054N	BRAVO 7 / BRAVO 7M / BRAVO 8 / BRAVO 8M / BRAVO 9	1 kit
SP 213	R151018	BST 800 / BST 800 BATTERY / BST 300	1 kit
SP 214 / NEW	R151025	BRAVO TURBO MAX > 2011 - a baionetta / bayonet	1 kit
SP 216	R151032	Connettore arancione a baionetta per BRAVO T.MAX / Orange bayonet connection for T.MAX	1 kit
SP 218	R151035	GE 20-2	1 kit
SP Z029	R210037	GE 21-1 / GE 21-1A	1 kit
SP Z094	R990023	GE BP / GE BTP MANOMETER / BTP 12 DIGITAL	1 kit
SP 217	R151052	OV 10 / OV 6 / GE 2000 / ARS (standard fitting)	1 kit
SP 215	R151030	OV 10 / OV 6 / GE 2000 / 2000 A.R.S. - (adapter 718/2005 glued in)	1 kit
SP Z006	R151131	OV10-40	1 kit
SP Z050	R210050	GE 230/800 / GE 230/1000	1 kit



SP Z031 - SP Z036			
Item	Part number	Description	Pcs
SP Z036	R211007	Art. 810 - Tubo 25 m/ø 21 mm - PVC Art. 810 - Hose 25 m/ø 21 mm - PVC	1
SP Z031	R211002	Tubo per TURBO MAX 25 m/ø 25 mm - PU Hose for TURBO MAX 25 m/ø 25 mm - PU	1

SP Z032 - SP Z033			
Item	Part number	Description	Pcs
SP Z032	R211003	Art. 850 - Tubo per gonfiatori elettrici 15 m/ø 40 mm - EPDM Art. 850 - Hose for electric pumps 15 m/ø 40 mm - EPDM	1
SP Z033	R211004	Art. 860 - Tubo per gonfiatori elettrici 15 m/ø 40 mm - PVC Art. 860 - Hose for electric pumps 15 m/ø 40 mm - PVC	1

SP Z034			
Item	Part number	Description	Pcs
SP Z034	R211005	Art. 866 - Tubo per controllo pressione 15 m/ø 6 mm - PU Art. 866 - Hose for pressure control 15 m/ø 6 mm - PU	1

SP 156 - SP 157			
Item	Part number	Description	Pcs
SP 156	R151023	Raccordo per tubo di controllo pressione e valvola di gonfiaggio (HR) Fitting for pressure control hose and inflation valve (HR)	1
SP 157	R151024	Raccordo per tubo di controllo pressione e valvola di gonfiaggio (BRAVO 2005/H3) Fitting for pressure control hose and inflation valve (BRAVO 2005/H3)	1



SP Z037 - SP Z030			
Item	Part number	Description	Pcs
SP Z037	R211008	Art. 785 - Fascetta stringitubo in acciaio inox / ø 25 mm Art. 785 - Stainless steel hose collar / ø 25 mm	1
SP Z030	R211001	Art. 790 - Fascetta stringitubo in acciaio inox / ø 40 mm Art. 790 - Stainless steel hose collar / ø 40 mm	1



SP 46			
Item	Part number	Description	Pcs
SP 46	R151046	Raccordo Tubo-Pompa per BRAVO 1/BRAVO 2/BRAVO 10 Hose-Pump fitting for BRAVO 1/BRAVO 2/BRAVO 10	1



SP Z024 - SP Z025			
Item	Part number	Description	Pcs
SP Z024	R210032	Art. 740 - Raccordo Tubo-Pompa per BRAVO 2000/ BRAVO 2000 ARS/OV 10/OV 6 - ø 40 mm Art. 740 - Hose-Pump fitting for BRAVO 2000/BRA- VO 2000 ARS/OV 10/OV 6 - ø 40 mm	1
SP Z025	R210033	Art. 741 - Raccordo Tubo-Pompa per BRAVO 2000/ BRAVO 2000 ARS/OV 10/OV 6 - ø 25 mm Art. 741 - Hose-Pump fitting for BRAVO 2000/BRA- VO 2000 ARS/OV 10/OV 6 - ø 25 mm	1



SP Z 134			
Item	Part number	Description	Pcs
SP Z 134	R151134	Raccordo a Y tubo-pompa Y hose-pump fitting	1



SP Z013 - SP Z014			
Item	Part number	Description	Pcs
SP Z013	R210017	Raccordo Tubo-Pompa per PCS/BRAVO 2000 IP 65/BRAVO 2000 ARS IP 65 - ø 40 mm Hose-Pump fitting for PCS/BRAVO 2000 IP 65/ BRAVO 2000 ARS IP 65 - ø 40 mm	1
SP Z014	R210018	Raccordo Tubo-Pompa per PCS/BRAVO 2000 IP 65/BRAVO 2000 ARS IP 65 - ø 25 mm Hose-Pump fitting for PCS/BRAVO 2000 IP 65/ BRAVO 2000 ARS IP 65 - ø 25 mm	1



SP Z026			
Item	Part number	Description	Pcs
SP Z026	R210034	Art. 795 - Riduzione in PVC Tubo- Raccordo - ø 25/20 mm Art. 795 - PVC reduction Hose- Fitting - ø 25/20 mm	1



SP 20			
Item	Part number	Description	Pcs
SP 20	R201020	Gancio di chiusura per GP 10 Closing clip for GP 10	1



## VALVOLE DI GONFIAGGIO

INFLATION VALVES

SP 43			
Item	Part number	Description	Pcs
SP 43	R201043	Tappo valvola Boston Boston valve cap	1



SP 129/2005			
Item	Part number	Description	Pcs
SP 129/2005/G	R601148	Valvola di gonfiaggio BRAVO 2005 - grigio Inflation valve BRAVO 2005 - grey	6
SP 129/2005/B	R601147	Valvola di gonfiaggio BRAVO 2005 - nero Inflation valve BRAVO 2005 - black	6



SP 129/2001			
Item	Part number	Description	Pcs
SP 129/2001/G	R601130	Valvola di gonfiaggio BRAVO 2001 - grigio Inflation valve BRAVO 2001 - grey	6
SP 129/2001/B	R601129	Valvola di gonfiaggio BRAVO 2001 - nero Inflation valve BRAVO 2001 - black	6



SP 129/2000			
Item	Part number	Description	Pcs
SP 129/2000/G	R601146	Valvola di gonfiaggio BRAVO 2000 - grigio Inflation valve BRAVO 2000 - grey	6
SP 129/2000/B	R601145	Valvola di gonfiaggio BRAVO 2000 - nero Inflation valve BRAVO 2000 - black	6



SP 136			
Item	Part number	Description	Pcs
SP 136	R601141	Chiave per valvole BRAVO 2000/BRAVO 2001/BRAVO 2004/BRAVO 2005/BRAVO 2014/SUPER VALVE/VA 100 Key for valves BRAVO 2000/BRAVO 2001/BRAVO 2004/BRAVO 2005/BRAVO 2014/SUPER VALVE/VA 100	1



SP 725			
Item	Part number	Description	Pcs
Art. 725	A942040N	Chiave per valvola BRAVO 260 H.V. Key for valve BRAVO 260 H.V.	1



## KIT DI RIPARAZIONE

REPAIR KIT

SP 17			
Item	Part number	Description	Pcs
SP 17	R101017	Collante professionale per PVC/tessuto spalmato/gomma sintetica (gr. 28) Professional glue for PVC/glazed fabrics/synthetic rubber (gr. 28)	1

INSTALLATION



SP 50			
Item	Part number	Description	Pcs
SP 50	R101060	Kit ricambi/riparazione Kit spare parts/repair	1

Kit completo di:  
1 tappo per valvola a vite  
2 tappi piccoli  
2 tappi medi  
1 raccordo per gonfiatore  
1 foglia PVC  
1 tubo di colla (5 gr)

Kit containing:  
1 boston valve  
2 small caps  
2 medium caps  
1 fitting for pump  
1 PVC patch  
1 glue tube (5 gr)



SP 55			
Item	Part number	Description	Pcs
SP 55	R101065	Kit colla (gr. 5) e foglia PVC Kit glue (gr. 5) and PVC patch	1





# ACCESSORI PER GOMMONI

ACCESSORIES FOR RIBS

SP 207 - SP 208

Item	Part number	Description	Pcs
SP 207	R605071	Supporto bandiera - grigio RAL 7001 Flag support - grey RAL 7001	1
SP 208	R605081	Base in gomma ø 90 mm - grigio RAL 7001 Rubber base ø 90 mm - grey RAL 7001	1



SP 175 - SP 103

Item	Part number	Description	Pcs
SP 75/B	R601075	Tappo di svuotamento + BASE - nero Empty plug + BASE - black	1 + 1
SP 103	R601076	Tappo di svuotamento (solo plug) - nero Empty plug (plug only) - black	1
SP 75/G	R601080	Tappo di svuotamento + BASE - grigio Empty plug + BASE - grey	1 + 1



# ALIMENTAZIONE GONFIATORI

ELECTRIC SUPPLY FOR PUMPS

Caricatori 120V, 230V, 12V / Morsetti / Batterie

Chargers 120V, 230V, 12V / Alligator clips / Batteries

ALIMENTAZIONE GONFIATORI - ELECTRIC SUPPLY FOR PUMPS

Item	Part number	Description
SP Z136	R990055	Battery charger for GE25 HP and KIT HP Battery
SP #33	R990033	SP33 - Battery charger for GE20-2, GE25 SL and KIT SL Batt230V / 120V charger for BK NIMH
SP #35	R990035	Battery charger for BST 800 BATT and BRAVO 12 BATT
SP #36	R990036	Battery charger for GE21-1A
SP 221	R151038	12V Cigarette plug for GE20-2 - GE25
SP 228	R151034	12V Cigarette plug for BST 800 BATT and BRAVO 12 BATT
SP Z051	R210051	12V Cigarette plug for GE21-1A
SP Z093	R990022	Alligators for GE20-2, BP12 and BTP12
SP 22	R210022	Battery for BST800 BATT and BR12 BATT
SP 21	R210021	Battery for GE20-2, GE21-1A e GE25SL
SP Z125	R151050	Case for BST 800 BATT
SP Z166	R401159	Connectors for TURBO MAX KIT
SP Z155	R990068	Cable with cigarette lighter for BST 300/ GE BP/ GE BTP
SP Z157	R990070	Power supply cable with cigarette lighter for GE BP/BTP
SP Z149	R990062	Clip for GE BP, GE BTP and Battery KIT

# BORSE

CARRY BAGS

BORSE - CARRY BAGS

Item	Part number	Description
SP 225	R151042	TURBO MAX
SP 227	R151044	GE 20-2
SP Z002	R151045	GE 21-1A
SP Z140	R151077	GE 25
SP 222	R151039	BST 800 BATTERY
SP 226	R151043	BST 800 BATT / BST 12 KITE - Trasparente antisabbia/transparent anti-sand
SP 230	R151069	BST 300 / BST 800
SP 224	R151041	BRAVO 12 BATT
SP Z138	R151074	GE BP / GE BP1
SP Z139	R151075	GE BTP
SP #31	R990031N	BP 12 (<2019)
SP #9	R990009N	BTP 12 MANO / BTP 12 DIGITAL (<2019)
SP Z028	R210036	SACCA/MESH BAG BRAVO 100 / BRAVO 101 / BRAVO 110/100D / GM 4WD



# RICAMBI PER ACCESSORI SUP

SPARE PARTS FOR SUP ACCESSORIES

SP 105			
Item	Part number	Description	Pcs
SP 105	R251010N	Ghiera per pagaie SUP Plastic screw collars for SUP paddles	1

SP Z040			
Item	Part number	Description	Pcs
SP Z040	R212003	Guaina in NBR per pagaie SUP NBR foam handle for SUP paddles	1

SP 106			
Item	Part number	Description	Pcs
SP 106	R251012	Bottone per pagaie SUP Push-pin for SUP paddles	1

SP 209 - SP 211			
Item	Part number	Description	Pcs
SP 209	R151029N	O-ring per pompa BRAVO SUP O-ring for BRAVO SUP pump	1
SP 211	R151033N	O-ring per pompa BRAVO SUP-3 O-ring for BRAVO SUP-3 pump	1

SP Z158			
Item	Part number	Description	Pcs
SP Z158	R605100N	Raccordo per sgonfiaggio sicuro Safe deflate adaptor	1

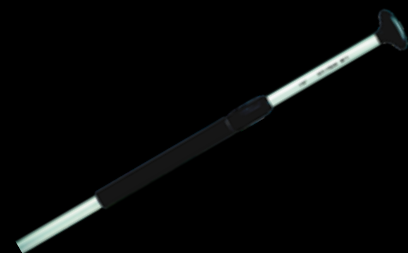

# ISTRUZIONI GENERALI PER I COMPONENTI FLESSIBILI

GENERAL INSTRUCTIONS ON SOFT PARTS

## Materiali

Tutti i materiali vengono testati ai raggi UV secondo la norma ISO 4582 con una simulazione di 5 anni di invecchiamento.

*They are all tested for the UV ray resistance in accordance to the UNI ISO 4582 NORM simulating 5 years aging.*

## Materials

### PVC

Noi usiamo solo PVC di produzione EUROPEA.

*We use EUROPEAN made PVC only*

### MPR

Miscela di materiali (MPR + PVC) che può essere incollato similmente alla gomma e che consente forti risparmi.

*Material compound (MPR + PVC) easy to be glued with a considerable product cost saving.*

## GOMMA RUBBER

È un elastomero (termopolimero di etilene-propilenediene) stampato su presse a compressione e vulcanizzato.

*Is an elastomer (thermo polymer of ethylene-propylene - diene) stamped on compression presses and vulcanised.*

### PU

Poliuretano (componenti per zattere di salvataggio)

*Polyurethane (parts for life rafts)*

## INCOLLAGGIO e/o SALDATURA

Gli accessori in MPR e GOMMA possono essere incollati con le colle bi-componenti in uso corrente presso i fabbricanti di gommoni.

*The MPR and RUBBER accessories can be glued with the bi-component glues currently used by rubber boat manufacturers.*

## GLUEING and/or WELDING

Gli accessori in PVC possono essere incollati con colle similari o elettrosaldati a RF (Radio Frequenza).

*The PVC accessories can be glued with similar glues or RF (radio Frequency thermo-welded).*

## COLORI

## COLOURS

Gli accessori standard sono in nero e grigio (RAL 7035). Colori diversi possono essere forniti su richiesta per lotti significativi.

*The standard accessories are black and grey (RAL 7035). Different colours can be supplied on request for large lots*

## IMBALLI

## BULK PACKING

Gli accessori, destinati ai produttori, sono forniti in scatole complete. Per le quantità per scatola consultare il listino prezzi.

*The fittings, intended for the producers, are supplied in complete boxes. Please see the price list as for the quantities per box.*

Immagini, testi e colori mostrati nel catalogo sono illustrativi. I prodotti possono subire modifiche senza preavviso.

*Images, texts and colours shown in the catalogue are illustrative. Products are subject to modifications without notification.*



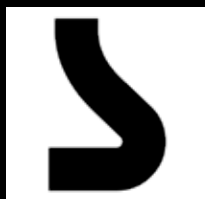

SCOPREGA SPA  
Via L. Da Vinci, 63  
Cassano d'Adda (Milan) Italy - 20062  
Phone: +39 0363 64240  
Fax +39 0363 64171  
[info@scoprega.it](mailto:info@scoprega.it)  
[www.scoprega.it](http://www.scoprega.it)